

SECTION **SEC**

SECURITY CONTROL SYSTEM

A
B
C

CONTENTS

<p>BASIC INSPECTION 5</p> <p>DIAGNOSIS AND REPAIR WORK FLOW 5</p> <p style="padding-left: 20px;">Work Flow5</p> <p>INSPECTION AND ADJUSTMENT 8</p> <p>ECM RE-COMMUNICATING FUNCTION8</p> <p style="padding-left: 20px;">ECM RE-COMMUNICATING FUNCTION : De- scription8</p> <p style="padding-left: 20px;">ECM RE-COMMUNICATING FUNCTION : Spe- cial Repair Requirement8</p> <p>SYSTEM DESCRIPTION 9</p> <p>INTELLIGENT KEY SYSTEM/ENGINE START FUNCTION 9</p> <p style="padding-left: 20px;">System Diagram9</p> <p style="padding-left: 20px;">System Description9</p> <p style="padding-left: 20px;">Component Parts Location12</p> <p style="padding-left: 20px;">Component Description14</p> <p>INFINITI VEHICLE IMMOBILIZER SYSTEM- NATS15</p> <p style="padding-left: 20px;">System Diagram15</p> <p style="padding-left: 20px;">System Description15</p> <p style="padding-left: 20px;">Component Parts Location17</p> <p style="padding-left: 20px;">Component Description19</p> <p>VEHICLE SECURITY SYSTEM20</p> <p style="padding-left: 20px;">System Diagram20</p> <p style="padding-left: 20px;">System Description20</p> <p style="padding-left: 20px;">Component Parts Location22</p> <p style="padding-left: 20px;">Component Description24</p> <p>DIAGNOSIS SYSTEM (BCM)25</p> <p>COMMON ITEM25</p> <p style="padding-left: 20px;">COMMON ITEM : CONSULT Function (BCM - COMMON ITEM)25</p> <p>INTELLIGENT KEY26</p>	<p>INTELLIGENT KEY : CONSULT Function (BCM - INTELLIGENT KEY)26</p> <p>THEFT ALM30</p> <p style="padding-left: 20px;">THEFT ALM : CONSULT Function (BCM - THEFT)30</p> <p>IMMU31</p> <p style="padding-left: 20px;">IMMU : CONSULT Function (BCM - IMMU)31</p> <p>DTC/CIRCUIT DIAGNOSIS32</p> <p>U1000 CAN COMM CIRCUIT32</p> <p>BCM32</p> <p style="padding-left: 20px;">BCM : Description32</p> <p style="padding-left: 20px;">BCM : DTC Logic32</p> <p style="padding-left: 20px;">BCM : Diagnosis Procedure32</p> <p>IPDM E/R32</p> <p style="padding-left: 20px;">IPDM E/R : Description32</p> <p style="padding-left: 20px;">IPDM E/R : DTC Logic32</p> <p style="padding-left: 20px;">IPDM E/R : Diagnosis Procedure33</p> <p>U1010 CONTROL UNIT (CAN)34</p> <p>BCM34</p> <p style="padding-left: 20px;">BCM : DTC Logic34</p> <p style="padding-left: 20px;">BCM : Diagnosis Procedure34</p> <p>P1610 LOCK MODE35</p> <p style="padding-left: 20px;">Description35</p> <p style="padding-left: 20px;">DTC Logic35</p> <p style="padding-left: 20px;">Diagnosis Procedure35</p> <p>P1611 ID DISCORD, IMMU-ECM36</p> <p style="padding-left: 20px;">Description36</p> <p style="padding-left: 20px;">DTC Logic36</p> <p style="padding-left: 20px;">Diagnosis Procedure36</p> <p>P1612 CHAIN OF ECM-IMMU38</p> <p style="padding-left: 20px;">Description38</p> <p style="padding-left: 20px;">DTC Logic38</p>
---	---

D
E

F
G

H
I

J
SEC

L
M

N
O

P

Diagnosis Procedure	38	Diagnosis Procedure	58
P1614 CHAIN OF IMMU-KEY	40	Component Inspection	60
Description	40	B2602 SHIFT POSITION	61
DTC Logic	40	Description	61
Diagnosis Procedure	40	DTC Logic	61
P1615 DIFFERENCE OF KEY	43	Diagnosis Procedure	61
Description	43	Component Inspection	62
DTC Logic	43	B2603 SHIFT POSITION	64
Diagnosis Procedure	43	Description	64
B2190 NATS ANTENNA AMP.	44	DTC Logic	64
Description	44	Diagnosis Procedure	64
DTC Logic	44	Component Inspection	66
Diagnosis Procedure	44	B2604 SHIFT POSITION	67
B2191 DIFFERENCE OF KEY	47	Description	67
Description	47	DTC Logic	67
DTC Logic	47	Diagnosis Procedure	67
Diagnosis Procedure	47	B2605 SHIFT POSITION	69
B2192 ID DISCORD, IMMU-ECM	48	Description	69
Description	48	DTC Logic	69
DTC Logic	48	Diagnosis Procedure	69
Diagnosis Procedure	48	B2608 STARTER RELAY	71
B2193 CHAIN OF ECM-IMMU	50	Description	71
Description	50	DTC Logic	71
DTC Logic	50	Diagnosis Procedure	71
Diagnosis Procedure	50	B260F ENGINE STATUS	73
B2195 ANTI-SCANNING	51	Description	73
Description	51	DTC Logic	73
DTC Logic	51	Diagnosis Procedure	73
Diagnosis Procedure	51	B26E8 CLUTCH INTERLOCK SWITCH	75
B2555 STOP LAMP	52	Description	75
Description	52	DTC Logic	75
DTC Logic	52	Diagnosis Procedure	75
Diagnosis Procedure	52	Component Inspection	76
Component Inspection	53	B26EA KEY REGISTRATION	77
B2556 PUSH-BUTTON IGNITION SWITCH	54	Description	77
Description	54	DTC Logic	77
DTC Logic	54	Diagnosis Procedure	77
Diagnosis Procedure	54	B2617 STARTER RELAY CIRCUIT	78
Component Inspection	55	Description	78
B2557 VEHICLE SPEED	56	DTC Logic	78
Description	56	Diagnosis Procedure	78
DTC Logic	56	B261E VEHICLE TYPE	80
Diagnosis Procedure	56	Description	80
B2560 STARTER CONTROL RELAY	57	DTC Logic	80
Description	57	Diagnosis Procedure	80
DTC Logic	57	B261F ASCD CLUTCH SWITCH	81
Diagnosis Procedure	57	Description	81
B2601 SHIFT POSITION	58	DTC Logic	81
Description	58	Diagnosis Procedure	81
DTC Logic	58	Component Inspection	82

B210B STARTER CONTROL RELAY	83	KEY WARNING LAMP	101	
Description	83	Description	101	A
DTC Logic	83	Component Function Check	101	
Diagnosis Procedure	83	Diagnosis Procedure	101	
B210C STARTER CONTROL RELAY	84	INTELLIGENT KEY SYSTEM/ENGINE		B
Description	84	START FUNCTION	102	
DTC Logic	84	Wiring Diagram - INTELLIGENT KEY SYSTEM/ ENGINE START FUNCTION -	102	C
Diagnosis Procedure	84			
B210D STARTER RELAY	85	INFINITI VEHICLE IMMOBILIZER SYSTEM-		D
Description	85	NATS	105	
DTC Logic	85	Wiring Diagram - IVIS -	105	
Diagnosis Procedure	85			
B210E STARTER RELAY	86	VEHICLE SECURITY SYSTEM	108	E
Description	86	Wiring Diagram - VEHICLE SECURITY SYSTEM		
DTC Logic	86	-	108	
Diagnosis Procedure	86			F
B210F SHIFT POSITION/CLUTCH INTER-		ECU DIAGNOSIS INFORMATION	109	
LOCK SWITCH	88			
Description	88	BCM	109	
DTC Logic	88	Reference Value	109	G
Diagnosis Procedure	88	Wiring Diagram - BCM -	133	
		Fail-safe	137	
		DTC Inspection Priority Chart	138	
		DTC Index	139	H
B2110 SHIFT POSITION/CLUTCH INTER-		IPDM E/R	142	
LOCK SWITCH	90	Reference Value	142	I
Description	90	Wiring Diagram - IPDM E/R -	149	
DTC Logic	90	Fail-safe	151	
Diagnosis Procedure	90	DTC Index	153	J
POWER SUPPLY AND GROUND CIRCUIT	92	SYMPTOM DIAGNOSIS	154	
BCM	92			
BCM : Diagnosis Procedure	92	ENGINE DOES NOT START WHEN INTELLI-		
		GENENT KEY IS INSIDE OF VEHICLE	154	SEC
IPDM E/R	92	Description	154	
IPDM E/R : Diagnosis Procedure	92	Diagnosis Procedure	154	L
KEY SLOT	94	SECURITY INDICATOR LAMP DOES NOT		
Description	94	TURN ON OR FLASH	155	M
Component Function Check	94	Description	155	
Diagnosis Procedure	94	Diagnosis Procedure	155	
KEY SLOT INDICATOR	95	VEHICLE SECURITY SYSTEM CANNOT BE		
Description	95	SET	156	N
Component Function Check	95			
Diagnosis Procedure	95	INTELLIGENT KEY	156	
HOOD SWITCH	97	INTELLIGENT KEY : Description	156	O
Description	97	INTELLIGENT KEY : Diagnosis Procedure	156	
Component Function Check	97			
Diagnosis Procedure	97	DOOR REQUEST SWITCH	156	P
Component Inspection	98	DOOR REQUEST SWITCH : Description	156	
SECURITY INDICATOR LAMP	99	DOOR REQUEST SWITCH : Diagnosis Proce-		
Description	99	dure	156	
Component Function Check	99	VEHICLE SECURITY ALARM DOES NOT		
Diagnosis Procedure	99	ACTIVATE	158	
		Description	158	
		Diagnosis Procedure	158	

INTELLIGENT KEY INSERT INFORMATION	
DOES NOT OPERATE	159
Description	159
Diagnosis Procedure	159
PRECAUTION	161
PRECAUTIONS	161
Precaution for Supplemental Restraint System (SRS) "AIR BAG" and "SEAT BELT PRE-TEN- SIONER"	161
	Precaution for Procedure without Cowl Top Cover. 161
REMOVAL AND INSTALLATION	162
KEY SLOT	162
Exploded View	162
Removal and Installation	162
PUSH BUTTON IGNITION SWITCH	163
Exploded View	163
Removal and Installation	163

DIAGNOSIS AND REPAIR WORK FLOW

< BASIC INSPECTION >

BASIC INSPECTION

DIAGNOSIS AND REPAIR WORK FLOW

Work Flow

INFOID:000000007753441

OVERALL SEQUENCE

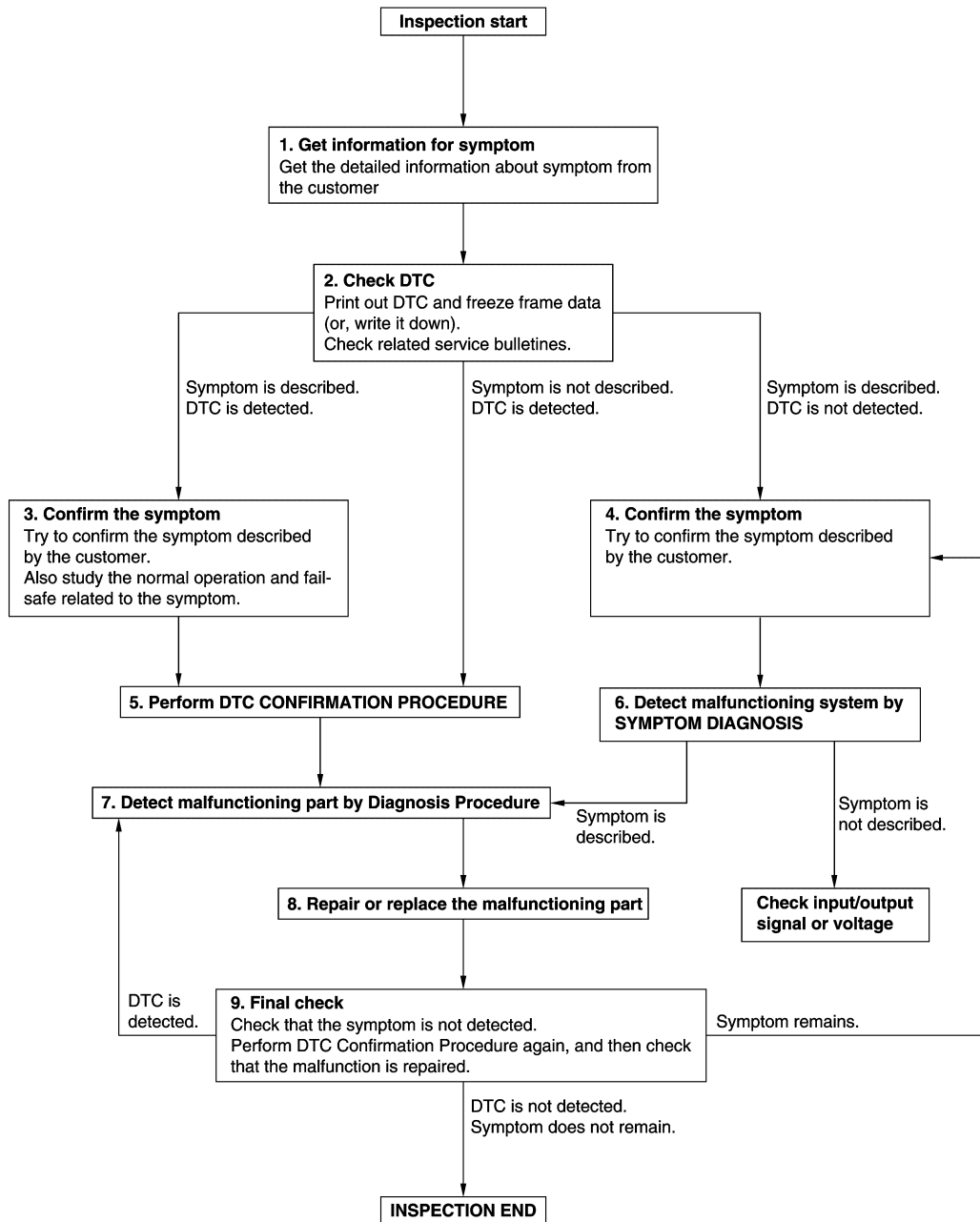

A
B
C
D
E
F
G
H
I
J
L
M
N
O
P

SEC

DETAILED FLOW

JMKIA8652GB

DIAGNOSIS AND REPAIR WORK FLOW

< BASIC INSPECTION >

1. GET INFORMATION FOR SYMPTOM

1. Get detailed information from the customer about the symptom (the condition and the environment when the incident/malfunction occurs).
2. Check operation condition of the function that is malfunctioning.

>> GO TO 2.

2. CHECK DTC

1. Check DTC.
2. Perform the following procedure if DTC is detected.
 - Record DTC and freeze frame data (Print them out using CONSULT.)
 - Erase DTC.
 - Study the relationship between the cause detected by DTC and the symptom described by the customer.
3. Check related service bulletins for information.

Are any symptoms described and any DTC detected?

Symptom is described, DTC is detected>>GO TO 3.

Symptom is described, DTC is not detected>>GO TO 4.

Symptom is not described, DTC is detected>>GO TO 5.

3. CONFIRM THE SYMPTOM

Try to confirm the symptom described by the customer.

Also study the normal operation and fail-safe related to the symptom.

Verify relation between the symptom and the condition when the symptom is detected.

>> GO TO 5.

4. CONFIRM THE SYMPTOM

Try to confirm the symptom described by the customer.

Verify relation between the symptom and the condition when the symptom is detected.

>> GO TO 6.

5. PERFORM DTC CONFIRMATION PROCEDURE

Perform DTC CONFIRMATION PROCEDURE for the detected DTC, and then check that DTC is detected again. At this time, always connect CONSULT to the vehicle, and check self diagnostic results in real time.

If two or more DTCs are detected, refer to [SEC-138. "DTC Inspection Priority Chart"](#) (BCM) or [SEC-153. "DTC Index"](#) (IPDM E/R), and determine trouble diagnosis order.

NOTE:

- Freeze frame data is useful if the DTC is not detected.
- Perform Component Function Check if DTC CONFIRMATION PROCEDURE is not included on Service Manual. This simplified check procedure is an effective alternative though DTC cannot be detected during this check.
If the result of Component Function Check is NG, it is the same as the detection of DTC by DTC CONFIRMATION PROCEDURE.

Is DTC detected?

YES >> GO TO 7.

NO >> Check according to [GI-43. "Intermittent Incident"](#).

6. DETECT MALFUNCTIONING SYSTEM BY SYMPTOM DIAGNOSIS

Detect malfunctioning system according to SYMPTOM DIAGNOSIS based on the confirmed symptom in step 4, and determine the trouble diagnosis order based on possible causes and symptom.

Is the symptom described?

YES >> GO TO 7.

NO >> Monitor input data from related sensors or check voltage of related module terminals using CONSULT.

7. DETECT MALFUNCTIONING PART BY DIAGNOSIS PROCEDURE

DIAGNOSIS AND REPAIR WORK FLOW

< BASIC INSPECTION >

Inspect according to Diagnosis Procedure of the system.

Is malfunctioning part detected?

YES >> GO TO 8.

NO >> Check according to [GI-43. "Intermittent Incident"](#).

8. REPAIR OR REPLACE THE MALFUNCTIONING PART

1. Repair or replace the malfunctioning part.
2. Reconnect parts or connectors disconnected during Diagnosis Procedure again after repair and replacement.
3. Check DTC. If DTC is detected, erase it.

>> GO TO 9.

9. FINAL CHECK

When DTC is detected in step 2, perform DTC CONFIRMATION PROCEDURE again, and then check that the malfunction is repaired securely.

When symptom is described by the customer, refer to confirmed symptom in step 3 or 4, and check that the symptom is not detected.

Is DTC detected and does symptom remain?

YES-1 >> DTC is detected: GO TO 7.

YES-2 >> Symptom remains: GO TO 4.

NO >> Before returning the vehicle to the customer, always erase DTC.

A
B
C
D
E
F
G
H
I
J
L
M
N
O
P

SEC

INSPECTION AND ADJUSTMENT

< BASIC INSPECTION >

INSPECTION AND ADJUSTMENT ECM RE-COMMUNICATING FUNCTION

ECM RE-COMMUNICATING FUNCTION : Description

INFOID:000000007467142

Performing the following procedure can automatically activate recommunication of ECM and BCM, but only when the ECM is replaced with a new one*.

*: New one means a virgin ECM that is never energized on-board.

(In this step, initialization procedure by CONSULT is not necessary)

NOTE:

- When registering new Key IDs or replacing the ECM that is not brand new, follow the instruction of CONSULT display.
- If multiple keys are attached to the key holder, separate them before beginning work.
- Distinguish keys with unregistered key IDs from those with registered IDs.

ECM RE-COMMUNICATING FUNCTION : Special Repair Requirement

INFOID:000000007467143

1. PERFORM ECM RECOMMUNICATING FUNCTION

1. Install ECM.
2. Insert the registered Intelligent Key* into key slot, turn ignition switch to "ON".
*: To perform this step, use the key that is used before performing ECM replacement.
3. Maintain ignition switch in the "ON" position for 5 seconds or more.
4. Turn ignition switch to "OFF".
5. Start engine.

Can engine be started?

- YES >> Procedure is complete.
NO >> Initialize control unit.

INTELLIGENT KEY SYSTEM/ENGINE START FUNCTION

< SYSTEM DESCRIPTION >

SYSTEM DESCRIPTION

INTELLIGENT KEY SYSTEM/ENGINE START FUNCTION

System Diagram

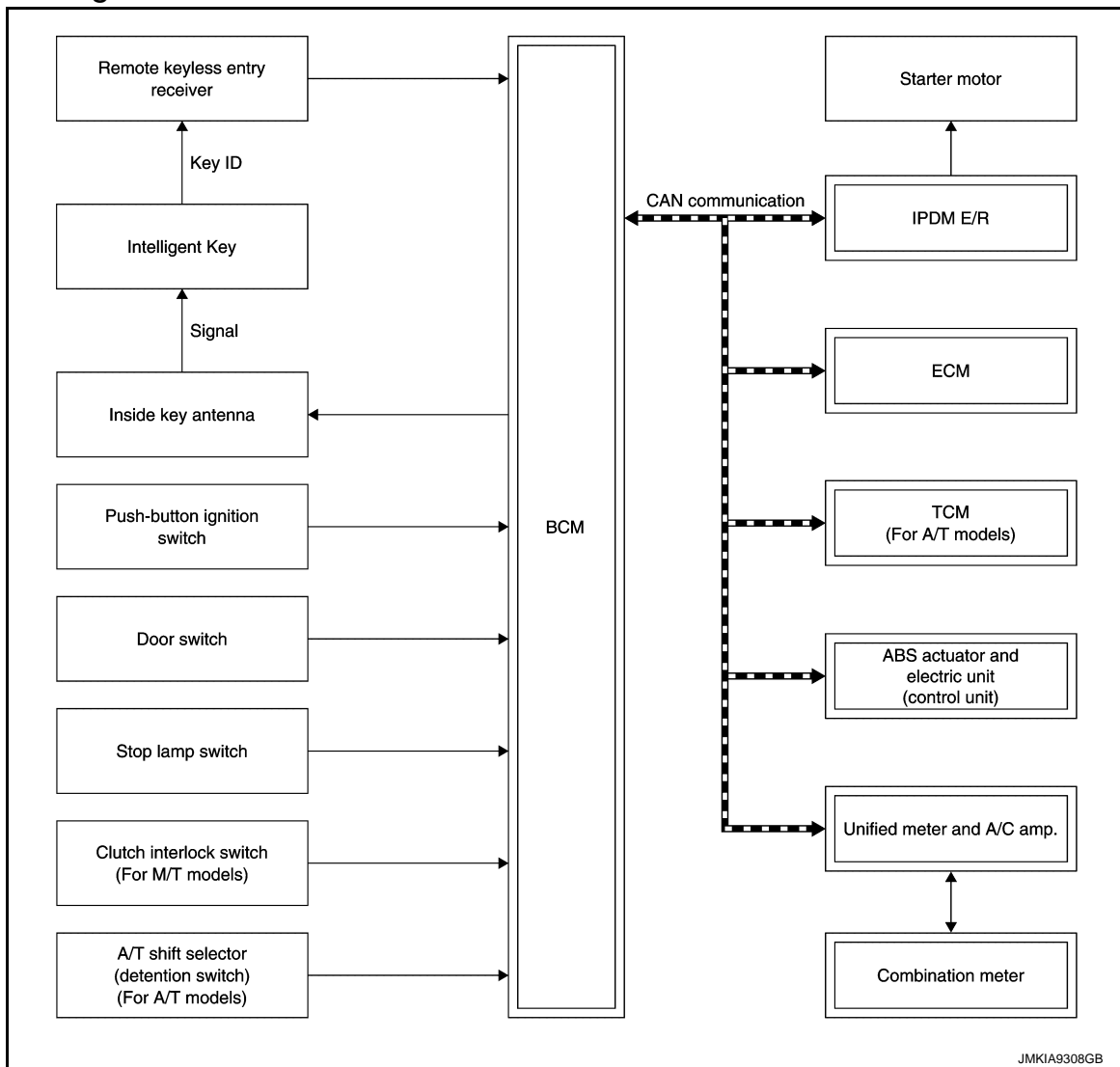

System Description

INFOID:000000007467145

SYSTEM DESCRIPTION

- The engine start function of Intelligent Key system is a system that makes it possible to start and stop the engine without removing the key. It verifies an electronic ID using two-way communication when pressing the push-button ignition switch while carrying the Intelligent Key, which operates based on the results of electronic ID verification of Intelligent Key using two-way communication between the Intelligent Key and the vehicle.

NOTE:

- The driver should carry the Intelligent Key at all times.
- Intelligent Key has 2 IDs [Intelligent Key and IVIS (NATS)]. It can perform the door lock/unlock operation and the push-button ignition switch operation when the registered Intelligent Key is carried.
- When the Intelligent Key battery is discharged, it can be used as emergency back-up by inserting the Intelligent Key to the key slot. At that time, perform the IVIS (NATS) ID verification. If it is used when the Intelligent Key is carried, perform the Intelligent Key ID verification.
- If the ID is successfully verified, and when push-button ignition switch is pressed, the engine can be started.
- Up to 4 Intelligent Keys can be registered (Including the standard Intelligent Key) upon request from the customer.

A
B
C
D
E
F
G
H
I
J
L
M
N
O
P

SEC

INTELLIGENT KEY SYSTEM/ENGINE START FUNCTION

< SYSTEM DESCRIPTION >

NOTE:

Refer to [DLK-16, "INTELLIGENT KEY SYSTEM : System Description"](#) for any functions other than engine start function of Intelligent Key system.

PRECAUTIONS FOR INTELLIGENT KEY SYSTEM

In the Intelligent Key system, the transponder [the chip for IVIS (NATS) ID verification] is integrated into the Intelligent Key. (For the conventional models, it is integrated into the mechanical key.) Therefore, the mechanical key cannot perform ID verification, and thus it cannot start the engine. Instead, IVIS (NATS) ID verification can be performed by inserting the Intelligent Key to the key slot, and then it can start the engine.

OPERATION WHEN INTELLIGENT KEY IS CARRIED

1. When the push-button ignition switch is pressed, the BCM activates the inside key antenna and transmits the request signal to the Intelligent Key.
2. The Intelligent Key receives the request signal and transmits the Intelligent Key ID signal to the BCM via the remote keyless entry receiver.
3. The Intelligent Key receives the Intelligent Key ID signal and verifies it with the registered ID.
4. BCM turns ACC relay ON and transmits the ignition power supply ON signal to IPDM E/R.
5. IPDM E/R turns the ignition relay ON and starts the ignition power supply.
6. BCM detects that the selector lever position and brake pedal operating condition (A/T models) or shift lever position and clutch pedal operation condition (M/T models).
7. BCM transmits the starter request signal via CAN communication to IPDM E/R and turns the starter relay in IPDM E/R ON if BCM judges that the engine start condition is satisfied.
8. IPDM E/R turns the starter control relay ON when receiving the starter request signal.
9. Power supply is supplied through the starter relay and the starter control relay to operate the starter motor and start cranking.

CAUTION:

If a malfunction is detected in the Intelligent Key system, the "KEY" warning lamp in the combination meter illuminates. At that time, the engine cannot be started.

10. When BCM receives feedback signal from ECM indicating that the engine is started, the BCM transmits a stop signal to IPDM E/R and stops cranking by turning OFF the starter motor relay. (If engine start is unsuccessful, cranking stops automatically within 5 seconds.)

CAUTION:

When the Intelligent Key is carried outside of the vehicle (inside key antenna detection area) while the power supply is in the ACC or ON position, even if the engine start condition* is satisfied, the engine cannot be started.

*: For the engine start condition, refer to "PUSH-BUTTON IGNITION SWITCH OPERATION PROCEDURE".

OPERATION RANGE

Engine can be started when Intelligent Key is inside the vehicle. However, sometimes engine may not start when Intelligent Key is on instrument panel or in glove box.

OPERATION WHEN KEY SLOT IS USED

When the Intelligent Key battery is discharged, it performs IVIS (NATS) ID verification between the integrated transponder and BCM by inserting the Intelligent Key into the key slot, and then the engine can be started.

For details relating to starting the engine using key slot, refer to [SEC-15, "System Description"](#).

POWER SUPPLY POSITION CHANGE TABLE BY PUSH-BUTTON IGNITION SWITCH OPERATION

The power supply position changing operation can be performed with the following operations.

NOTE:

- When an Intelligent Key is within the detection area of inside key antenna and when it is inserted to the key slot, it is equivalent to the operations below.
- When starting the engine, the BCM monitors under the engine start conditions,

A/T models

- Brake pedal operating condition
- A/T selector lever position
- Vehicle speed

M/T models

- Clutch pedal operating condition

INTELLIGENT KEY SYSTEM/ENGINE START FUNCTION

< SYSTEM DESCRIPTION >

- Vehicle speed

Vehicle speed: less than 4 km/h (2.5 MPH)

Power supply position	Engine start/stop condition			Push-button ignition switch operation frequency
	A/T models		M/T models	
	Selector lever position	Brake pedal operation condition	Clutch pedal operation condition	
OFF → ACC	—	Not depressed	Not depressed	1
OFF → ACC → ON	—	Not depressed	Not depressed	2
OFF → ACC → ON → OFF	—	Not depressed	Not depressed	3
OFF → START ACC → START ON → START	P or N position	Depressed	Depressed	1
Engine is running → OFF	—	—	—	1

Vehicle speed: 4 km/h (2.5 MPH) or more

Power supply position	Engine start/stop condition			Push-button ignition switch operation frequency
	A/T models		M/T models	
	Selector lever position	Brake pedal operation condition	Clutch pedal operation condition	
Engine is running → ACC	—	—	—	Emergency stop operation
Engine stall return operation while driving	N position	Not depressed	Depressed	1

Emergency stop operation

- Press and hold the push-button ignition switch for 2 seconds or more.
- Press the push-button ignition switch 3 times or more within 1.5 seconds.

A
B
C
D
E
F
G
H
I
J
L
M
N
O
P

SEC

INTELLIGENT KEY SYSTEM/ENGINE START FUNCTION

< SYSTEM DESCRIPTION >

Component Parts Location

INFOID:000000007467146

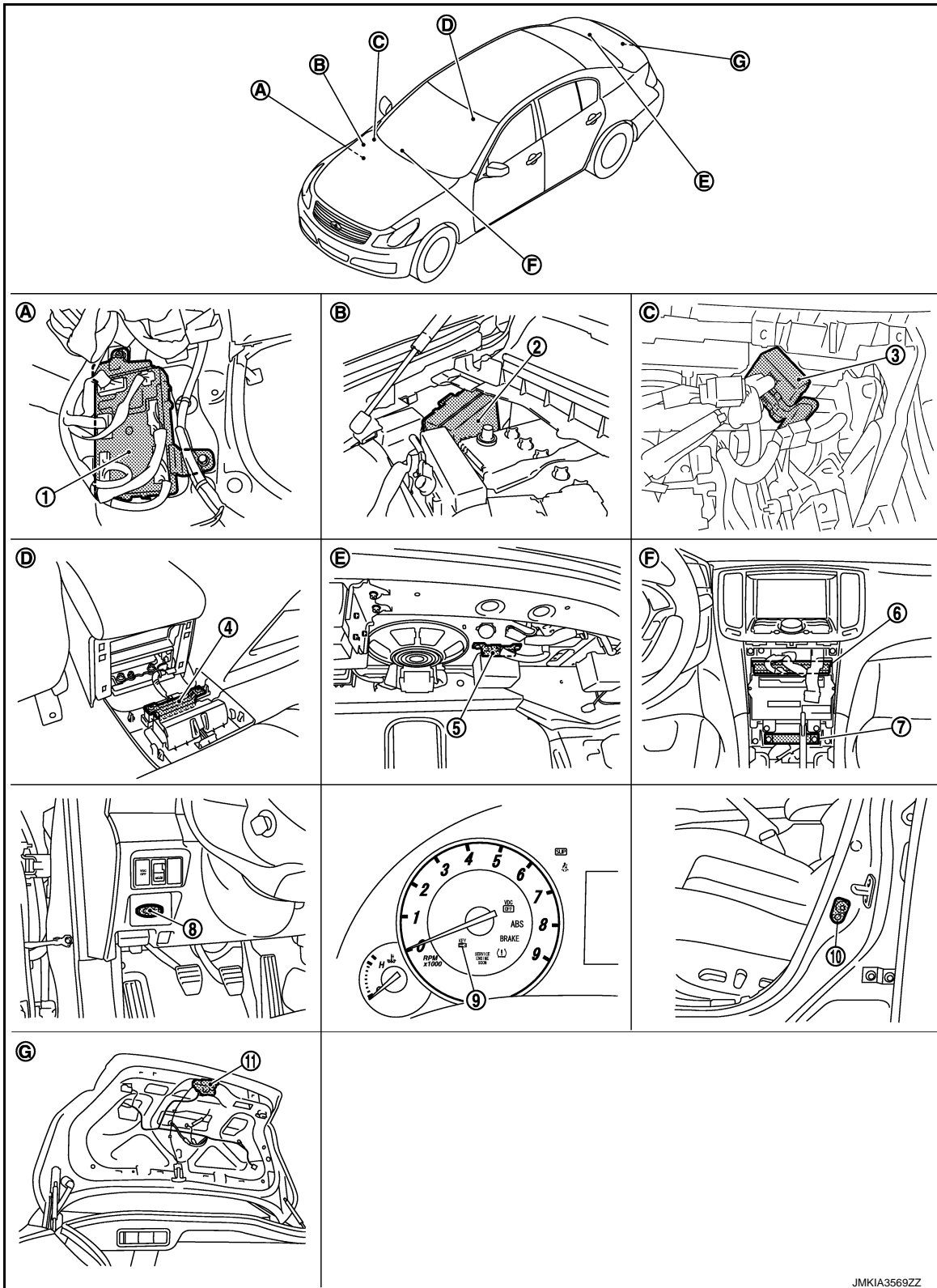

JMKIA3569ZZ

- 1. BCM
- 4. Inside key antenna (console)
- 7. Inside key antenna (instrument center)

- 2. IPDM E/R
- 5. Inside key antenna (trunk room)
- 8. Key slot

- 3. Remote keyless entry receiver
- 6. Unified meter and A/C amp.
- 9. Combination meter (Key warning lamp)

INTELLIGENT KEY SYSTEM/ENGINE START FUNCTION

< SYSTEM DESCRIPTION >

- | | | |
|---|--|---|
| 10. Driver side door switch | 11. Trunk lid lock assembly (trunk room lamp switch) | |
| A. Dash side lower (Passenger side). | B. Engine room dash panel (RH). | C. View with instrument assist lower panel removed. |
| D. View with console rear finisher removed. | E. View with trunk rear finisher (upper) removed. | F. Behind cluster lid C |
| G. View with trunk lid finisher removed. | | |

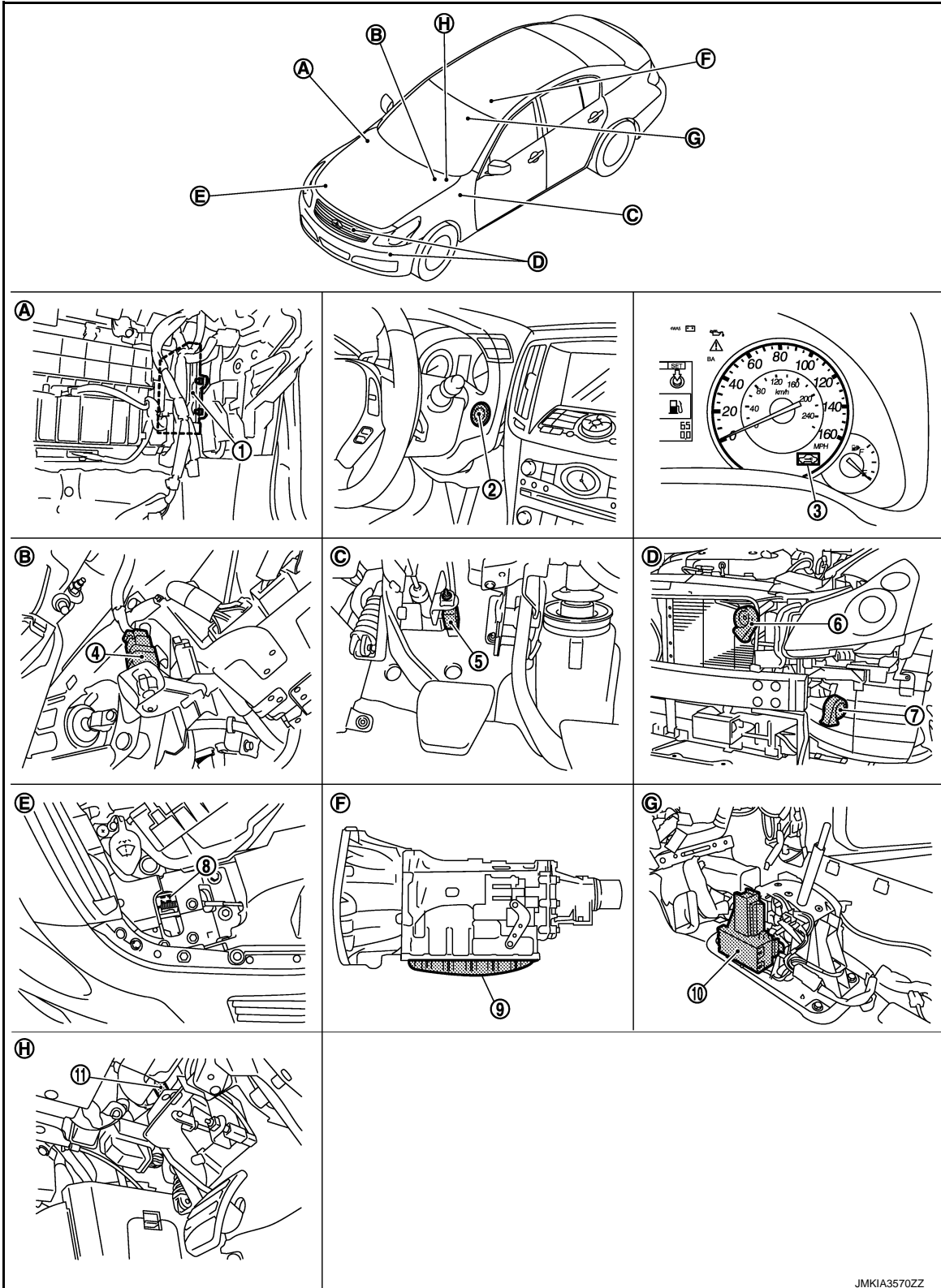

A
B
C
D
E
F
G
H
I
J
K
L
M
N
O
P

SEC

JMKIA3570ZZ

INTELLIGENT KEY SYSTEM/ENGINE START FUNCTION

< SYSTEM DESCRIPTION >

- | | | |
|---|--|---|
| 1. ECM | 2. Push-button ignition switch | 3. Combination meter (Security indicator) |
| 4. Stop lamp switch | 5. Clutch interlock switch | 6. Horn (high) |
| 7. Horn (low) | 8. Hood switch | 9. TCM |
| 10. A/T shift selector (detention switch) | 11. • ASCD clutch switch (ASCD models)
• ICC clutch switch (ICC models) | |
| A. View with instrument assist lower panel removed. | B. View with instrument driver lower cover removed. | C. View with instrument driver lower cover removed. |
| D. View with front bumper removed. | E. View with hood switch incorporated into hood lock (RH). | F. Inside of A/T (built into A/T). |
| G. View with center console assembly removed. | H. View with instrument driver lower cover removed. | |

Component Description

INFOID:000000007467147

Component	Reference
Push-button ignition switch	SEC-54
Door switch	DLK-66
A/T shift selector (detention switch) (A/T models)	SEC-58
Inside key antenna	DLK-59
Remote keyless entry receiver	DLK-82
Stop lamp switch	SEC-52
TCM (A/T models)	SEC-67
Clutch interlock switch (M/T models)	SEC-75
Starter relay	SEC-71
Starter control relay	SEC-57
Security indicator lamp	SEC-99
Key warning lamp	SEC-101

INFINITI VEHICLE IMMOBILIZER SYSTEM-NATS

< SYSTEM DESCRIPTION >

INFINITI VEHICLE IMMOBILIZER SYSTEM-NATS

System Diagram

INFOID:000000007467148

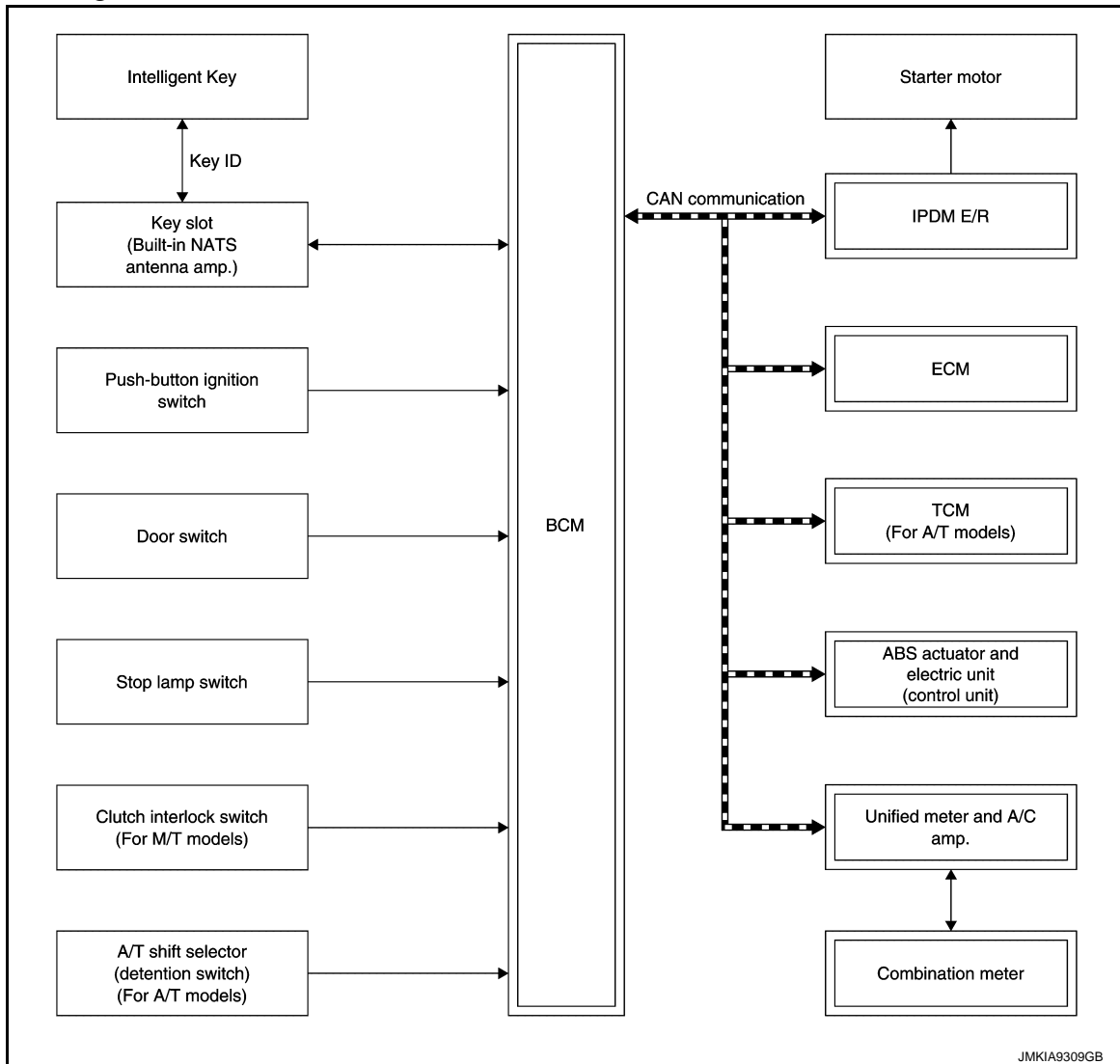

System Description

INFOID:000000007467149

SYSTEM DESCRIPTION

- The IVIS (NATS) is an anti-theft system that registers an Intelligent Key ID to the vehicle and prevents the engine from being started by an unregistered Intelligent Key. It has higher protection against auto theft involving the duplication of mechanical keys.
- It performs ID verification when starting the engine in the same way as the Intelligent Key system. But, it performs the IVIS (NATS) ID verification when inserting the Intelligent Key and performs the Intelligent Key ID verification when carrying the Intelligent Key.
- The mechanical key integrated in the Intelligent Key cannot start the engine. When the Intelligent Key battery is discharged, the IVIS (NATS) ID verification memorized to the transponder integrated with Intelligent Key is performed by inserting the Intelligent Key into the key slot. If the verification results are OK, the engine start operation can be performed by the push-button ignition switch operation.
- Locate the security indicator lamp and apply the anti-theft system equipment sticker that warns that the IVIS (NATS) is on board the model.
- Security indicator lamp always blinks when the power supply position is in the except ON position.
- Up to 4 Intelligent Keys can be registered (including the standard ignition key) upon request from the owner.
- Specified registration is required when replacing ECM, BCM, or Intelligent Key. For the registrations procedures for IVIS (NATS) and Intelligent Key when installing the BCM, follow the instruction of CONSULT display.

A

B

C

D

E

F

G

H

I

J

SEC

L

M

N

O

P

INFINITI VEHICLE IMMOBILIZER SYSTEM-NATS

< SYSTEM DESCRIPTION >

- Possible symptom of IVIS (NATS) malfunction is “Engine cannot start”. The engine can be started with the Intelligent Key system and IVIS (NATS). Identify the possible causes according to “Work Flow”. Refer to [SEC-5, "Work Flow"](#).
- If ECM other than genuine part is installed, the engine cannot be started. For ECM replacement procedure, refer to [EC-32, "ADDITIONAL SERVICE WHEN REPLACING CONTROL UNIT \(ECM\) : Special Repair Requirement"](#).

PRECAUTIONS FOR KEY REGISTRATION

- The key registration is a procedure that erases the current IVIS (NATS) ID once, and then registers a new ID operation. Therefore a registered Intelligent Key is necessary for this procedure. Before starting the registration operation collect all registered Intelligent Keys from the customer.
- When registering the Intelligent Key, perform only one procedure to simultaneously register both ID (IVIS “NATS” ID and Intelligent Key ID).
The IVIS (NATS) ID registration is the procedure that registers the ID stored into the transponder (integrated in Intelligent Key) to BCM.
The Intelligent key ID registration is the procedure that registers the ID to BCM.
- When performing the Intelligent Key system registration only, the engine cannot be started by inserting the key into the key slot. When performing the IVIS (NATS) registration only, the engine cannot be started by the operation when carrying the key. The registrations of both systems should be performed.

SECURITY INDICATOR LAMP

- Warns that the vehicle is equipped with IVIS (NATS).
- Security indicator lamp always blinks when the ignition switch is in the except ON position.

NOTE:

Because security indicator lamp is highly efficient, the battery is barely affected.

INFINITI VEHICLE IMMOBILIZER SYSTEM-NATS

< SYSTEM DESCRIPTION >

Component Parts Location

INFOID:000000007753442

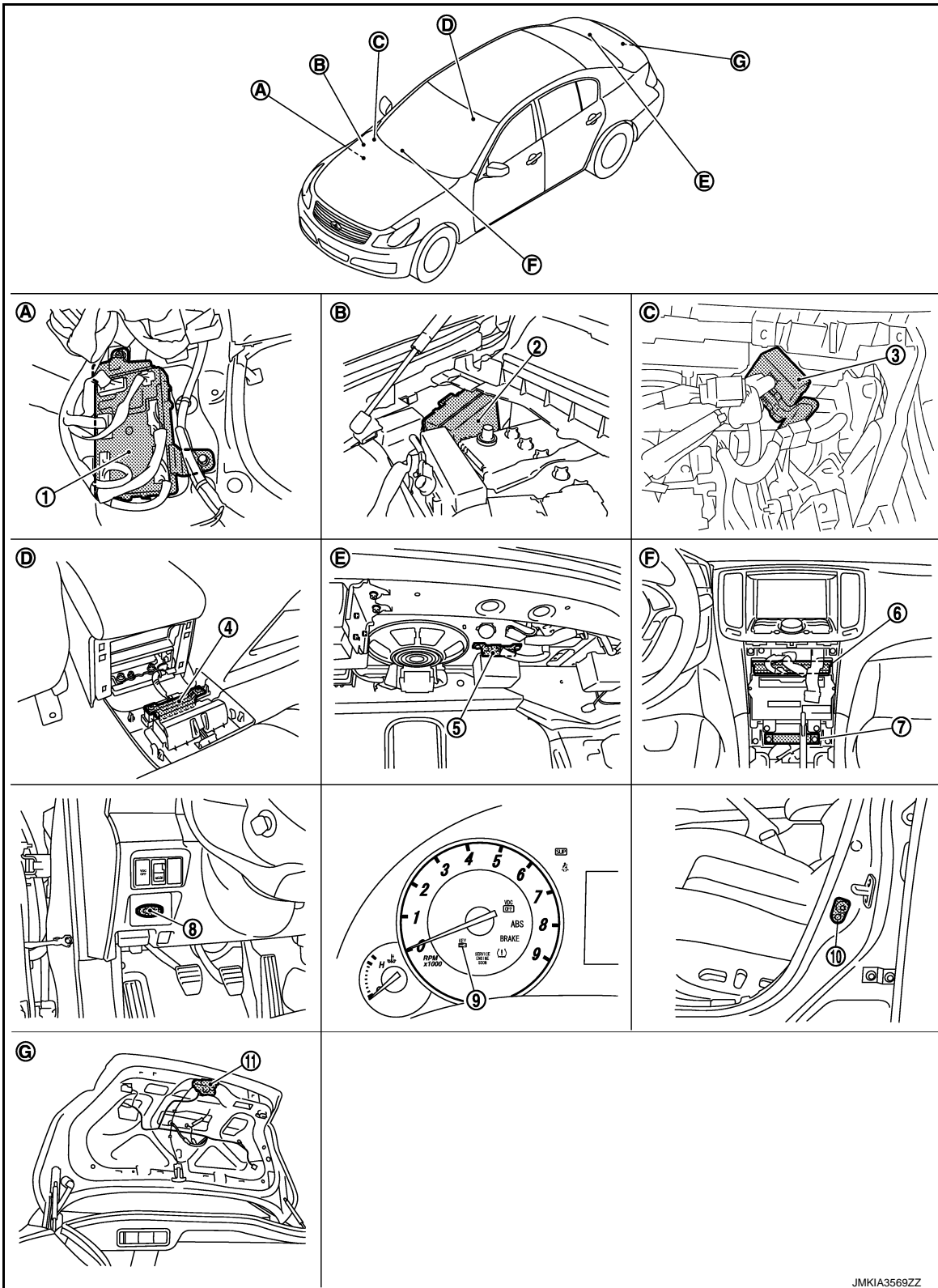

- 1. BCM
- 4. Inside key antenna (console)
- 7. Inside key antenna (instrument center)

- 2. IPDM E/R
- 5. Inside key antenna (trunk room)
- 8. Key slot

- 3. Remote keyless entry receiver
- 6. Unified meter and A/C amp.
- 9. Combination meter (Key warning lamp)

JMKIA3569ZZ

A
B
C
D
E
F
G
H
I
J
L
M
N
O
P

SEC

INFINITI VEHICLE IMMOBILIZER SYSTEM-NATS

< SYSTEM DESCRIPTION >

- | | | |
|---|--|---|
| 10. Driver side door switch | 11. Trunk lid lock assembly (trunk room lamp switch) | |
| A. Dash side lower (Passenger side). | B. Engine room dash panel (RH). | C. View with instrument assist lower panel removed. |
| D. View with console rear finisher removed. | E. View with trunk rear finisher (upper) removed. | F. Behind cluster lid C |
| G. View with trunk lid finisher removed. | | |

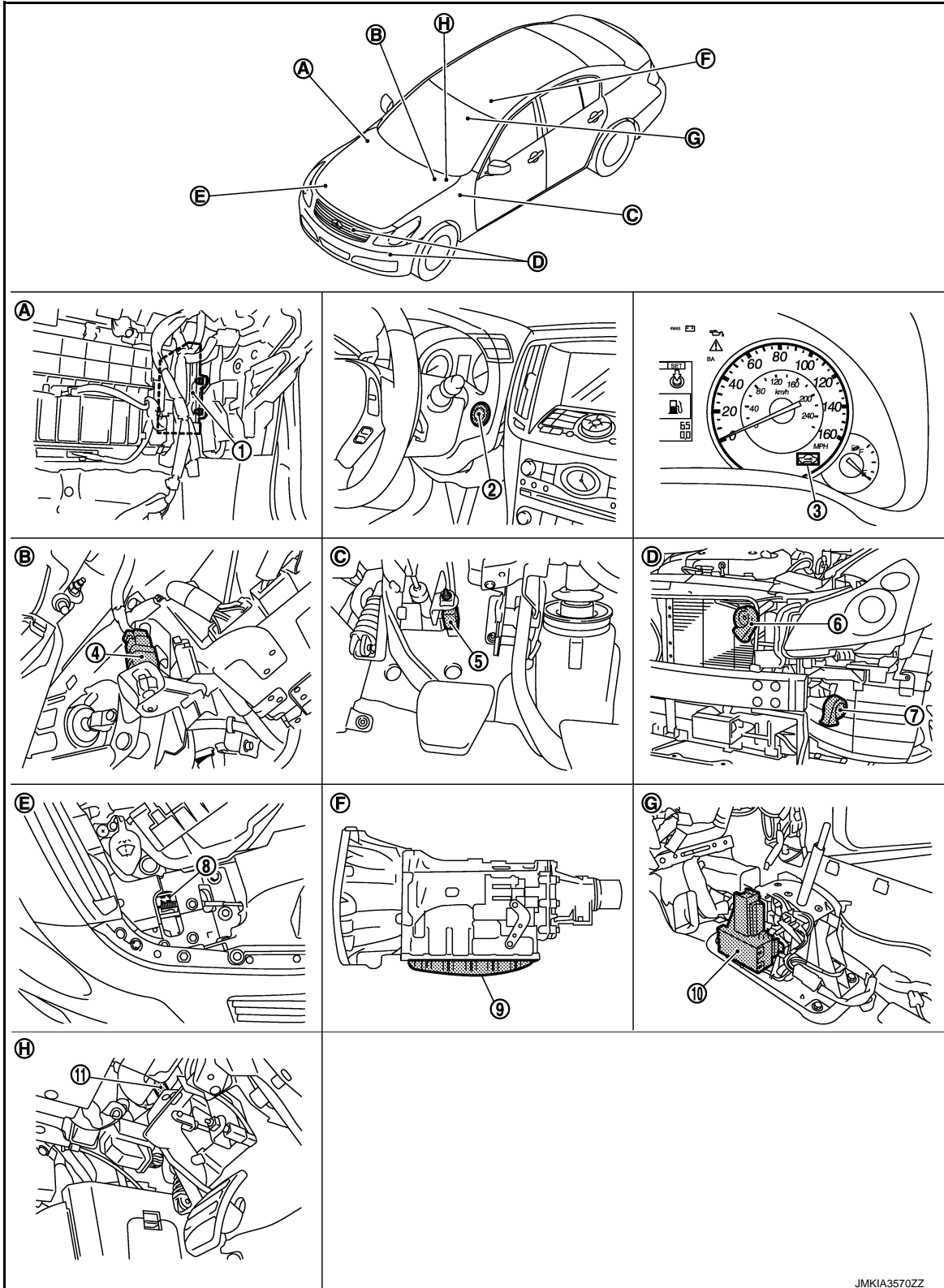

JMKIA3570ZZ

INFINITI VEHICLE IMMOBILIZER SYSTEM-NATS

< SYSTEM DESCRIPTION >

- | | | |
|---|--|---|
| 1. ECM | 2. Push-button ignition switch | 3. Combination meter (Security indicator) |
| 4. Stop lamp switch | 5. Clutch interlock switch | 6. Horn (high) |
| 7. Horn (low) | 8. Hood switch | 9. TCM |
| 10. A/T shift selector (detention switch) | 11. <ul style="list-style-type: none"> • ASCD clutch switch (ASCD models) • ICC clutch switch (ICC models) | |
| A. View with instrument assist lower panel removed. | B. View with instrument driver lower cover removed. | C. View with instrument driver lower cover removed. |
| D. View with front bumper removed. | E. View with hood switch incorporated into hood lock (RH). | F. Inside of A/T (built into A/T). |
| G. View with center console assembly removed. | H. View with instrument driver lower cover removed. | |

Component Description

INFOID:000000007467151

Component	Reference
Push-button ignition switch	SEC-54
Door switch	DLK-66
Key slot	SEC-94
A/T shift selector (detention switch) (A/T models)	SEC-67
Stop lamp switch	SEC-52
TCM (A/T models)	SEC-67
Clutch interlock switch (M/T models)	SEC-75
Starter relay	SEC-71
Starter control relay	SEC-83
Security indicator lamp	SEC-99

SEC

VEHICLE SECURITY SYSTEM

< SYSTEM DESCRIPTION >

VEHICLE SECURITY SYSTEM

System Diagram

INFOID:000000007467152

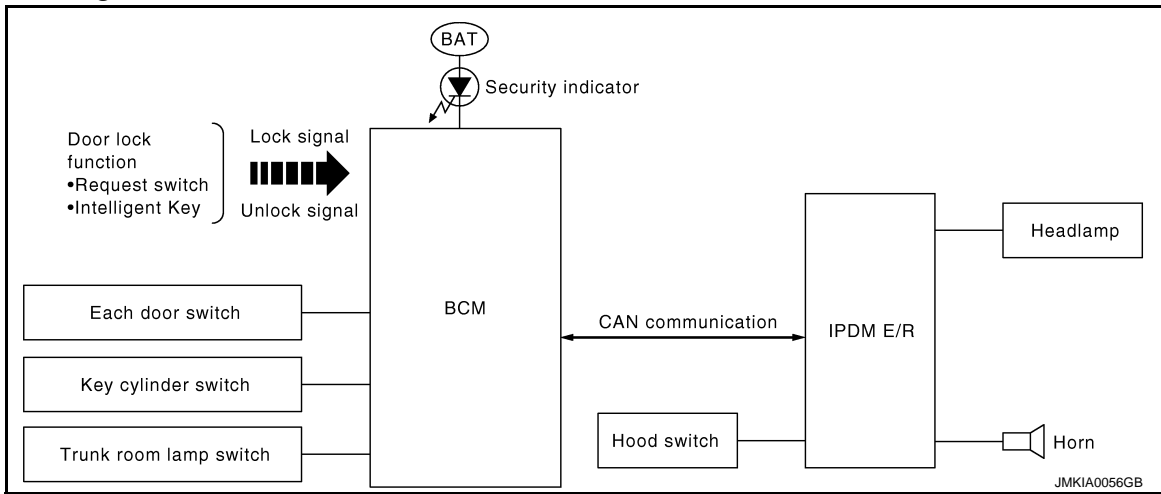

System Description

INFOID:000000007467153

OPERATION FLOW

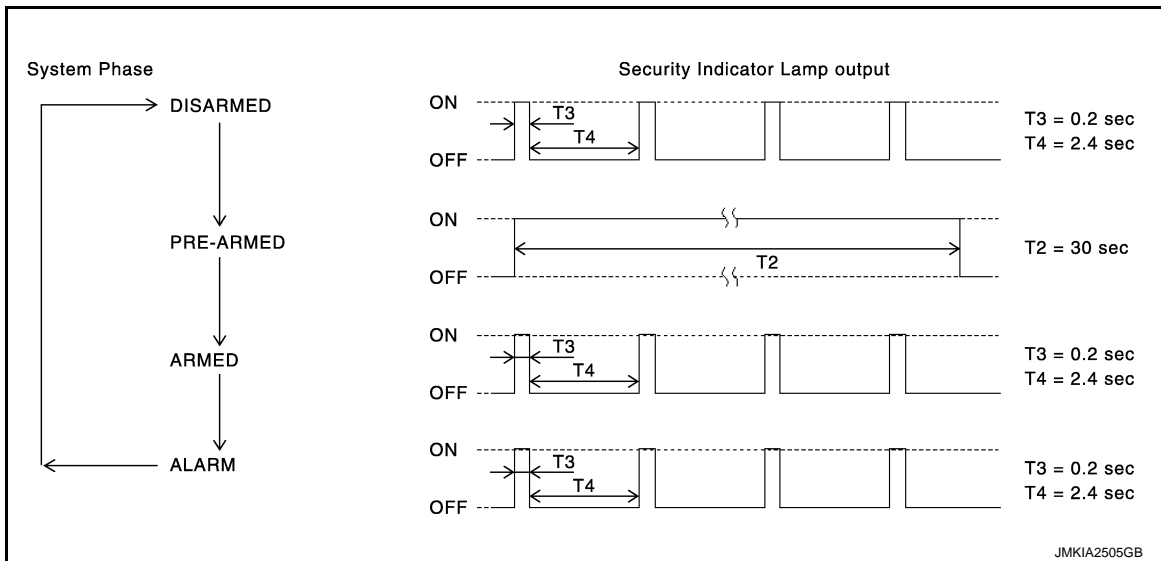

SETTING THE VEHICLE SECURITY SYSTEM

Initial Condition

Ignition switch is in OFF position.

Disarmed Phase

- When any door or trunk lid is open, the vehicle security system is set in the disarmed phase on the assumption that the owner is inside or near the vehicle.
- When the vehicle security system is in the disarmed phase, the security indicator lamp blinks every 2.4 seconds.

Pre-armed Phase and Armed Phase

When the following operation is performed, the vehicle security system turns into the “pre-armed” phase. (The security indicator lamp illuminates.)

1. BCM receives LOCK signal from door request switch or Intelligent Key, after all doors are closed.
2. Security indicator lamp illuminates for 30 seconds. Then, the system automatically shifts into the “armed” phase.

CANCELING THE SET VEHICLE SECURITY SYSTEM

VEHICLE SECURITY SYSTEM

< SYSTEM DESCRIPTION >

When one of the following operations is performed, the armed phase is canceled.

1. Unlock the all doors with the door request switch or Intelligent Key.
2. Turn ignition switch "ON" or "ACC" position.

CANCELING THE ALARM OPERATION OF THE VEHICLE SECURITY SYSTEM

When unlocking the all doors with the door request switch or Intelligent Key the alarm operation is canceled.

ACTIVATING THE ALARM OPERATION OF THE VEHICLE SECURITY SYSTEM

Check that the system is in the armed phase. (Security indicator lamp blinks every 2.4 seconds.)

When the following operation 1 or 2 is performed, the system sounds the horns and blinks the headlamps for about 50 seconds.

1. Trunk lid, any door or hood is opened during armed phase.
2. Disconnecting and connecting the battery connector before canceling armed phase.

A
B
C
D
E
F
G
H
I
J
L
M
N
O
P

SEC

VEHICLE SECURITY SYSTEM

< SYSTEM DESCRIPTION >

Component Parts Location

INFOID:000000007753443

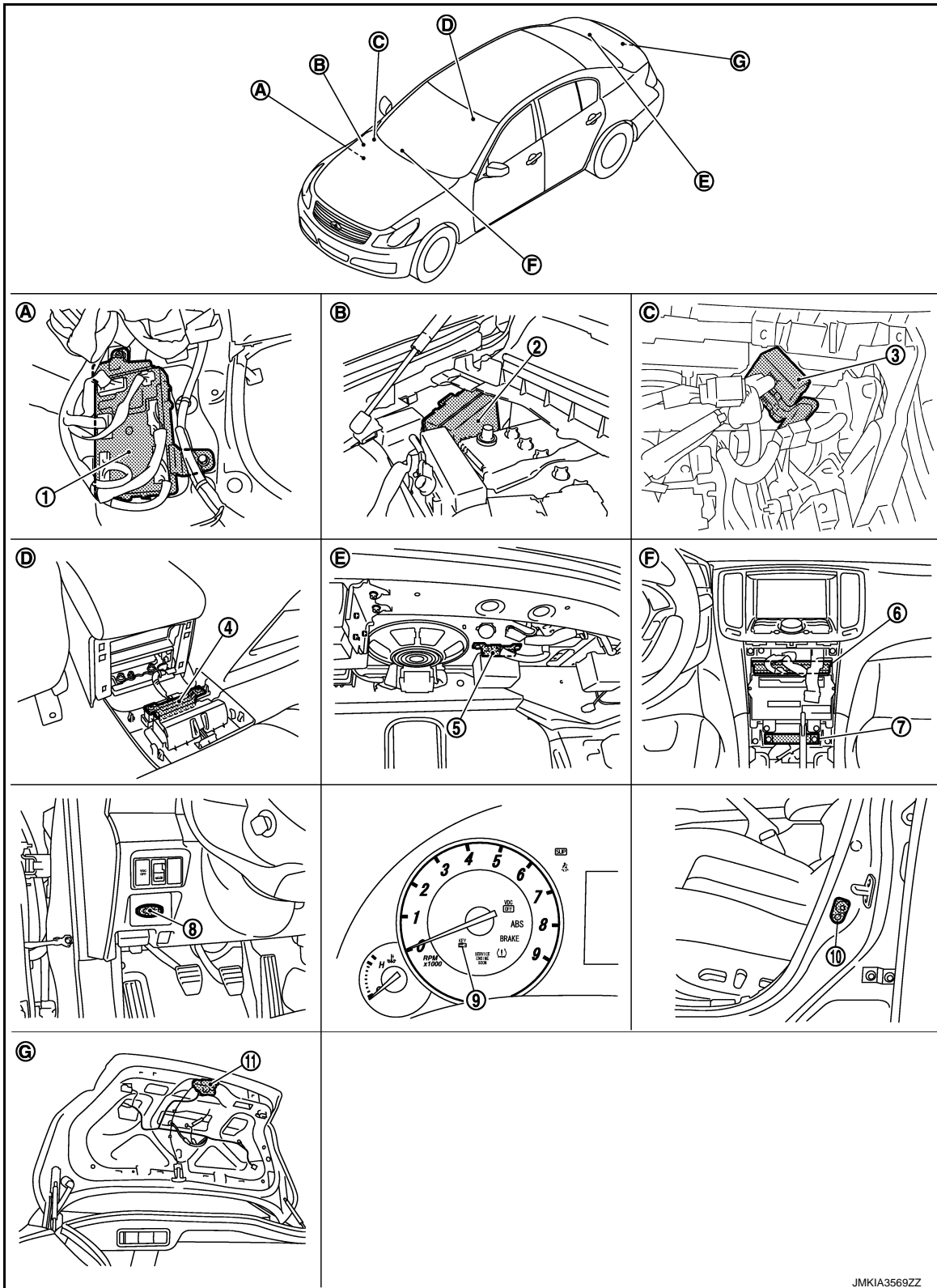

JMKIA3569ZZ

- | | | |
|---|------------------------------------|---|
| 1. BCM | 2. IPDM E/R | 3. Remote keyless entry receiver |
| 4. Inside key antenna (console) | 5. Inside key antenna (trunk room) | 6. Unified meter and A/C amp. |
| 7. Inside key antenna (instrument center) | 8. Key slot | 9. Combination meter (Key warning lamp) |

VEHICLE SECURITY SYSTEM

< SYSTEM DESCRIPTION >

- | | | |
|---|--|---|
| 10. Driver side door switch | 11. Trunk lid lock assembly (trunk room lamp switch) | |
| A. Dash side lower (Passenger side). | B. Engine room dash panel (RH). | C. View with instrument assist lower panel removed. |
| D. View with console rear finisher removed. | E. View with trunk rear finisher (upper) removed. | F. Behind cluster lid C |
| G. View with trunk lid finisher removed. | | |

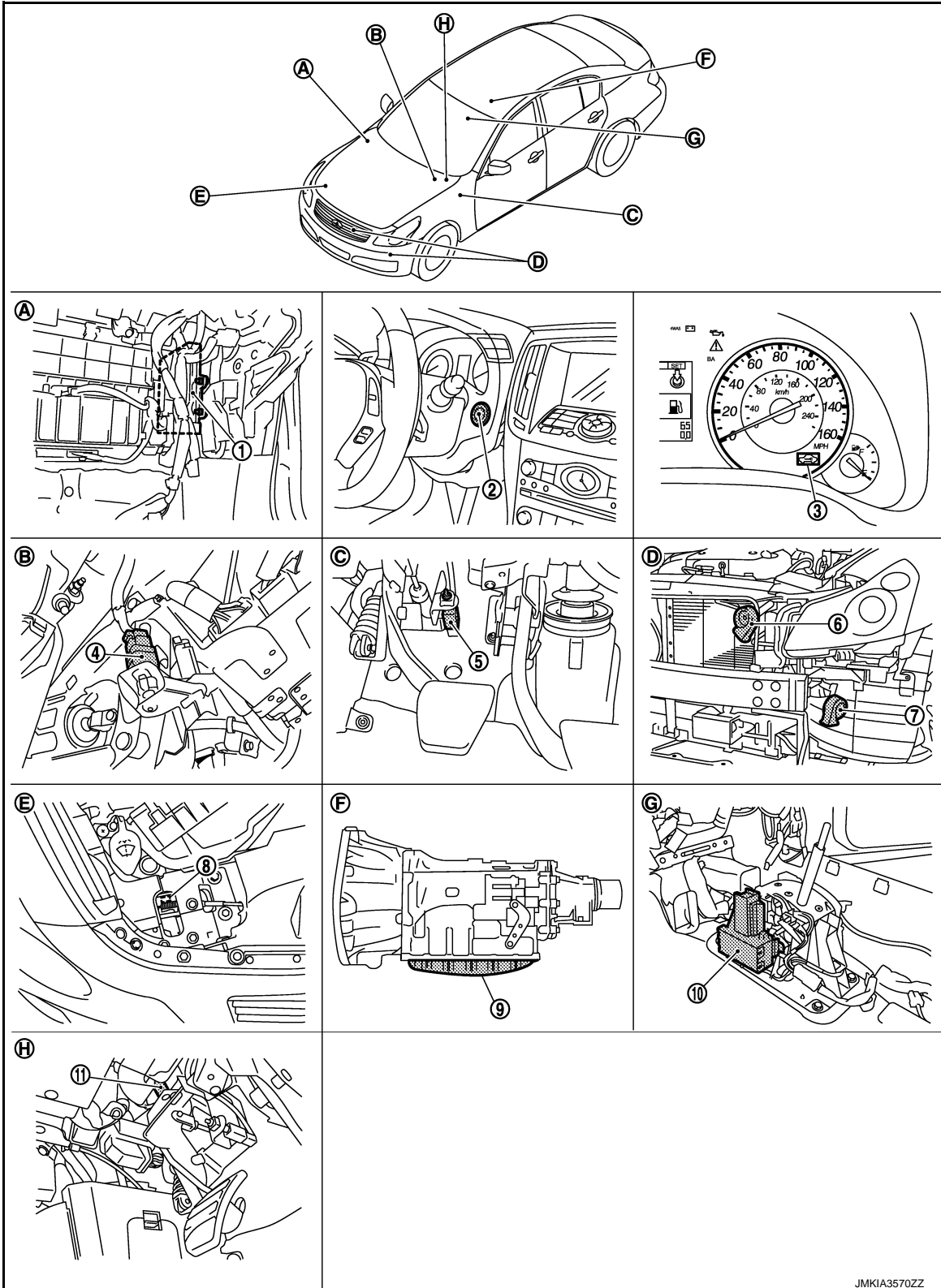

JMKIA3570ZZ

VEHICLE SECURITY SYSTEM

< SYSTEM DESCRIPTION >

- | | | |
|---|--|---|
| 1. ECM | 2. Push-button ignition switch | 3. Combination meter (Security indicator) |
| 4. Stop lamp switch | 5. Clutch interlock switch | 6. Horn (high) |
| 7. Horn (low) | 8. Hood switch | 9. TCM |
| 10. A/T shift selector (detention switch) | 11. • ASCD clutch switch (ASCD models)
• ICC clutch switch (ICC models) | |
| A. View with instrument assist lower panel removed. | B. View with instrument driver lower cover removed. | C. View with instrument driver lower cover removed. |
| D. View with front bumper removed. | E. View with hood switch incorporated into hood lock (RH). | F. Inside of A/T (built into A/T). |
| G. View with center console assembly removed. | H. View with instrument driver lower cover removed. | |

Component Description

INFOID:000000007467155

Component	Reference
Security indicator lamp	SEC-99
Door switch	DLK-66
Trunk room lamp switch	DLK-78
Hood switch	SEC-97

DIAGNOSIS SYSTEM (BCM)

< SYSTEM DESCRIPTION >

DIAGNOSIS SYSTEM (BCM) COMMON ITEM

COMMON ITEM : CONSULT Function (BCM - COMMON ITEM)

INFOID:000000007753445

APPLICATION ITEM

CONSULT performs the following functions via CAN communication with BCM.

Diagnosis mode	Function Description
Work Support	Changes the setting for each system function.
Self Diagnostic Result	Displays the diagnosis results judged by BCM.
CAN Diag Support Monitor	Monitors the reception status of CAN communication viewed from BCM.
Data Monitor	The BCM input/output signals are displayed.
Active Test	The signals used to activate each device are forcibly supplied from BCM.
Ecu Identification	The BCM part number is displayed.
Configuration	This function is not used even though it is displayed.

SYSTEM APPLICATION

BCM can perform the following functions for each system.

NOTE:

It can perform the diagnosis modes except the following for all sub system selection items.

x: Applicable item

System	Sub system selection item	Diagnosis mode		
		Work Support	Data Monitor	Active Test
Door lock	DOOR LOCK	x	x	x
Rear window defogger	REAR DEFOGGER		x	x
Warning chime	BUZZER		x	x
Interior room lamp timer	INT LAMP	x	x	x
Exterior lamp	HEAD LAMP	x	x	x
Wiper and washer	WIPER	x	x	x
Turn signal and hazard warning lamps	FLASHER	x	x	x
—	AIR CONDITONER*			
• Intelligent Key system • Engine start system	INTELLIGENT KEY	x	x	x
Combination switch	COMB SW		x	
Body control system	BCM	x		
IVIS - NATS	IMMU		x	x
Interior room lamp battery saver	BATTERY SAVER	x	x	x
Trunk lid open	TRUNK		x	x
Vehicle security system	THEFT ALM	x	x	x
RAP system	RETAINED PWR		x	
Signal buffer system	SIGNAL BUFFER		x	x
TPMS	AIR PRESSURE MONITOR	x	x	x

NOTE:

*: This item is displayed, but is not used.

FREEZE FRAME DATA (FFD)

The BCM records the following vehicle condition at the time a particular DTC is detected, and displays on CONSULT.

DIAGNOSIS SYSTEM (BCM)

< SYSTEM DESCRIPTION >

CONSULT screen item	Indication/Unit	Description	
Vehicle Speed	km/h	Vehicle speed of the moment a particular DTC is detected	
Odo/Trip Meter	km	Total mileage (Odometer value) of the moment a particular DTC is detected	
Vehicle Condition	SLEEP>LOCK	Power position status of the moment a particular DTC is detected	While turning BCM status from low power consumption mode to normal mode (Power supply position is "LOCK"*)
	SLEEP>OFF		While turning BCM status from low power consumption mode to normal mode (Power supply position is "OFF".)
	LOCK>ACC		While turning power supply position from "LOCK"* to "ACC"
	ACC>ON		While turning power supply position from "ACC" to "IGN"
	RUN>ACC		While turning power supply position from "RUN" to "ACC" (Vehicle is stopping and selector lever is except P position.)
	CRANK>RUN		While turning power supply position from "CRANKING" to "RUN" (From cranking up the engine to run it)
	RUN>URGENT		While turning power supply position from "RUN" to "ACC" (Emergency stop operation)
	ACC>OFF		While turning power supply position from "ACC" to "OFF"
	OFF>LOCK		While turning power supply position from "OFF" to "LOCK"*
	OFF>ACC		While turning power supply position from "OFF" to "ACC"
	ON>CRANK		While turning power supply position from "IGN" to "CRANKING"
	OFF>SLEEP		While turning BCM status from normal mode (Power supply position is "OFF".) to low power consumption mode
	LOCK>SLEEP		While turning BCM status from normal mode (Power supply position is "LOCK"*.) to low power consumption mode
	LOCK		Power supply position is "LOCK"*
	OFF		Power supply position is "OFF" (Ignition switch OFF)
	ACC		Power supply position is "ACC" (Ignition switch ACC)
	ON		Power supply position is "IGN" (Ignition switch ON with engine stopped)
	ENGINE RUN		Power supply position is "RUN" (Ignition switch ON with engine running)
CRANKING	Power supply position is "CRANKING" (At engine cranking)		
IGN Counter	0 - 39	The number of times that ignition switch is turned ON after DTC is detected <ul style="list-style-type: none"> • The number is 0 when a malfunction is detected now. • The number increases like 1 → 2 → 3...38 → 39 after returning to the normal condition whenever ignition switch OFF → ON. • The number is fixed to 39 until the self-diagnosis results are erased if it is over 39. 	

NOTE:

*: Power supply position shifts to "LOCK" from "OFF", when ignition switch is in the OFF position, selector lever is in the P position (A/T models), and any of the following conditions are met.

- Closing door
- Opening door
- Door is locked using door request switch
- Door is locked using Intelligent Key

The power supply position shifts to "ACC" when the push-button ignition switch (push switch) is pushed at "LOCK".

INTELLIGENT KEY

INTELLIGENT KEY : CONSULT Function (BCM - INTELLIGENT KEY)

INFOID:000000007753444

WORK SUPPORT

DIAGNOSIS SYSTEM (BCM)

< SYSTEM DESCRIPTION >

Monitor item	Description	A
CONFIRM KEY FOB ID	It can be checked whether Intelligent Key ID code is registered or not in this mode.	A
AUTO LOCK SET	Auto door lock time can be changed in this mode. <ul style="list-style-type: none"> • MODE 1: 1 minute • MODE 2: 5 minutes • MODE 3: 30 seconds • MODE 4: 2 minutes 	B
LOCK/UNLOCK BY I-KEY	Door lock/unlock function by door request switch (driver side and passenger side) mode can be changed to operate (ON) or not operate (OFF) in this mode.	C
ENGINE START BY I-KEY	Engine start function mode can be changed to operate (ON) or not operate (OFF) with this mode.	D
TRUNK/GLASS HATCH OPEN	Buzzer reminder function mode by trunk opener request switch can be changed to operate (ON) or not operate (OFF) with this mode.	E
PANIC ALARM SET	Panic alarm button pressing time on Intelligent Key remote control button can be selected from the following with this mode. <ul style="list-style-type: none"> • MODE 1: 0.5 sec. • MODE 2: Non-operation • MODE 3: 1.5 sec. 	F
PW DOWN SET	Unlock button pressing time on Intelligent Key button can be selected from the following with this mode. <ul style="list-style-type: none"> • MODE 1: 3 sec. • MODE 2: Non-operation • MODE 3: 5 sec. 	G
TRUNK OPEN DELAY	Trunk button pressing on Intelligent Key button can be selected as per the following in this mode. <ul style="list-style-type: none"> • MODE 1: Press and hold • MODE 2: Press twice • MODE 3: Press and hold, or press twice 	H
LO- BATT OF KEY FOB WARN	Intelligent Key low battery warning mode can be changed to operate (ON) or not operate (OFF) with this mode.	I
ANTI KEY LOCK IN FUNCTI	Key reminder function mode can be changed to operate (ON) or not operate (OFF) with this mode.	J
HAZARD ANSWER BACK	Hazard reminder function mode can be selected from the following with this mode. <ul style="list-style-type: none"> • LOCK ONLY: Door lock operation only • UNLOCK ONLY: Door unlock operation only • LOCK/UNLOCK: Lock/unlock operation • OFF: Non-operation 	K
ANS BACK I-KEY LOCK	Buzzer reminder function (lock operation) mode by door request switch (driver side and passenger side) can be selected from the following with this mode. <ul style="list-style-type: none"> • Horn chirp: Sound horn • Buzzer: Sound Intelligent Key warning buzzer • OFF: Non-operation 	L
ANS BACK I-KEY UNLOCK	Buzzer reminder function (unlock operation) mode by door request switch can be changed to operate (ON) or not operate (OFF) with this mode.	M
SHORT CRANKING OUTPUT	Starter motor can operate during the times below. <ul style="list-style-type: none"> • 70 msec • 100 msec • 200 msec 	N
INSIDE ANT DIAGNOSIS	This function allows inside key antenna self-diagnosis.	O
HORN WITH KEYLESS LOCK	Horn reminder function mode by Intelligent Key button can be changed to operate (ON) or not operate (OFF) with this mode.	P

SEC

SELF-DIAG RESULT

Refer to [BCS-74, "DTC Index"](#).

DATA MONITOR

DIAGNOSIS SYSTEM (BCM)

< SYSTEM DESCRIPTION >

Monitor Item	Condition
REQ SW -DR	Indicates [ON/OFF] condition of door request switch (driver side).
REQ SW -AS	Indicates [ON/OFF] condition of door request switch (passenger side).
REQ SW -BD/TR	Indicates [ON/OFF] condition of trunk opener request switch.
PUSH SW	Indicates [ON/OFF] condition of push-button ignition switch.
IGN RLY2 -F/B	Indicates [ON/OFF] condition of ignition relay 2.
ACC RLY-FB	NOTE: This item is displayed, but cannot be monitored.
CLUTCH SW*1	Indicates [ON/OFF] condition of clutch switch.
BRAKE SW 1	Indicates [ON/OFF]*2 condition of brake switch power supply.
BRAKE SW 2	Indicates [ON/OFF] condition of brake switch.
DETE/CANCL SW	Indicates [ON/OFF] condition of P position.
SFT PN/N SW	Indicates [ON/OFF] condition of P or N position.
S/L -LOCK	NOTE: This item is displayed, but can not be monitored.
S/L -UNLOCK	NOTE: This item is displayed, but can not be monitored.
S/L RELAY -F/B	NOTE: This item is displayed, but can not be monitored.
UNLK SEN -DR	Indicates [ON/OFF] condition of driver door UNLOCK status.
PUSH SW -IPDM	Indicates [ON/OFF] condition of push-button ignition switch.
IGN RLY1 -F/B	Indicates [ON/OFF] condition of ignition relay 1.
DETE SW -IPDM	Indicates [ON/OFF] condition of P position.
SFT PN -IPDM	Indicates [ON/OFF] condition of P or N position.
SFT P -MET	Indicates [ON/OFF] condition of P position.
SFT N -MET	Indicates [ON/OFF] condition of N position.
ENGINE STATE	Indicates [STOP/STALL/CRANK/RUN] condition of engine states.
S/L LOCK-IPDM	NOTE: This item is displayed, but can not be monitored.
S/L UNLK-IPDM	NOTE: This item is displayed, but can not be monitored.
S/L RELAY-REQ	NOTE: This item is displayed, but can not be monitored.
VEH SPEED 1	Display the vehicle speed signal received from combination meter by numerical value [Km/h].
VEH SPEED 2	Display the vehicle speed signal received from ABS or VDC or TCM by numerical value [Km/h].
DOOR STAT-DR	Indicates [LOCK/READY/UNLOCK] condition of driver side door status.
DOOR STAT-AS	Indicates [LOCK/READY/UNLOCK] condition of passenger side door status.
ID OK FLAG	Indicates [SET/RESET] condition of key ID.
PRMT ENG STRT	Indicates [SET/RESET] condition of engine start possibility.
PRMT RKE STRT	NOTE: This item is displayed, but cannot be monitored.
KEY SW -SLOT	Indicates [ON/OFF] condition of key slot.
TRNK/HAT MNTR	Indicates [ON/OFF] condition of trunk lid.
RKE-LOCK	Indicates [ON/OFF] condition of LOCK signal from Intelligent Key.
RKE-UNLOCK	Indicates [ON/OFF] condition of UNLOCK signal from Intelligent Key.
RKE-TR/BD	Indicates [ON/OFF] condition of TRUNK OPEN signal from Intelligent Key.
RKE-PANIC	Indicates [ON/OFF] condition of PANIC button of Intelligent Key.

DIAGNOSIS SYSTEM (BCM)

< SYSTEM DESCRIPTION >

Monitor Item	Condition
RKE-P/W OPEN	Indicates [ON/OFF] condition of P/W DOWN signal from Intelligent Key.
RKE-MODE CHG	Indicates [ON/OFF] condition of MODE CHANGE signal from Intelligent Key.
RKE OPE COUN1	When remote keyless entry receiver receives the signal transmitted while operating on Intelligent Key, the numerical value start changing.
RKE OPE COUN2	NOTE: This item is displayed, but cannot be monitored.

*1: It is displayed but does not operate on M/T models.

*2: OFF is displayed when brake pedal is depressed while brake switch power supply is OFF.

ACTIVE TEST

Test item	Description
BATTERY SAVER	This test is able to check interior room lamp operation. The interior room lamp is activated after "ON" on CONSULT screen is touched.
PW REMOTO DOWN SET	This test is able to check power window down operation. The power window down is activated after "ON" on CONSULT screen is touched.
OUTSIDE BUZZER	This test is able to check Intelligent Key warning buzzer operation. The Intelligent Key warning buzzer is activated after "ON" on CONSULT screen is touched.
INSIDE BUZZER	This test is able to check warning chime in combination meter operation. <ul style="list-style-type: none"> • Take away warning chime sounds when "TAKE OUT" on CONSULT screen is touched. • Key warning chime sounds when "KEY" on CONSULT screen is touched. • OFF position warning chime sounds when "KNOB" on CONSULT screen is touched.
INDICATOR	This test is able to check warning lamp operation. <ul style="list-style-type: none"> • "KEY" Warning lamp illuminates when "KEY ON" on CONSULT screen is touched. • "KEY" Warning lamp blinks when "KEY IND" on CONSULT screen is touched.
INT LAMP	This test is able to check interior room lamp operation. The interior room lamp is activated after "ON" on CONSULT screen is touched.
LCD	This test is able to check meter display information <ul style="list-style-type: none"> • Engine start information displays when "BP N" on CONSULT screen is touched. • Engine start information displays when "BP I" on CONSULT screen is touched. • Key ID warning displays when "ID NG" on CONSULT screen is touched. • ROTAT: This item is displayed, but can not be monitored. • P position warning displays when "SFT P" on CONSULT screen is touched. • Intelligent Key insert information displays when "INSRT" on CONSULT screen is touched. • Intelligent Key low battery warning displays when "BATT" on CONSULT screen is touched. • Take away through window warning displays when "NO KY" on CONSULT screen is touched. • Take away warning display when "OUTKEY" on CONSULT screen is touched. • OFF position warning display when "LK WN" on CONSULT screen is touched.
TRUNK/GLASS HATCH	This test is able to check trunk lid opener actuator open operation. This actuator opens when "OPEN" on CONSULT screen is touched.
FLASHER	This test is able to check security hazard lamp operation. The hazard lamps are activated after "LH/RH/OFF" on CONSULT screen is touched.
HORN	This test is able to check horn operation. The horn is activated after "ON" on CONSULT screen is touched.
P RANGE	This test is able to check A/T shift selector power supply A/T shift selector power is supplied when "ON" on CONSULT screen is touched.
ENGINE SW ILLUMI	This test is able to check push-ignition switch illumination operation. Push-ignition switch illumination illuminates when "ON" on CONSULT screen is touched.
LOCK INDICATOR	This test is able to check LOCK indicator in push-ignition switch operation. LOCK indicator in push-ignition switch illuminates when "ON" on CONSULT screen is touched.
ACC INDICATOR	This test is able to check ACC indicator in push-ignition switch operation. ACC indicator in push-ignition switch illuminates when "ON" on CONSULT screen is touched.
IGNITION ON IND	This test is able to check on indicator in push-ignition switch operation. ON indicator in push-ignition switch illuminates when "ON" on CONSULT screen is touched.

DIAGNOSIS SYSTEM (BCM)

< SYSTEM DESCRIPTION >

Test item	Description
KEY SLOT ILLUMI	This test is able to check key slot illumination operation. Key slot illumination blinks when "ON" on CONSULT screen is touched.
TRUNK/BACK DOOR	This test is able to check trunk lid opener actuator open operation. This actuator opens when "OPEN" on CONSULT screen is touched.

THEFT ALM

THEFT ALM : CONSULT Function (BCM - THEFT)

INFOID:000000007467158

DATA MONITOR

Monitored Item	Description
REQ SW-DR	Indicates [ON/OFF] condition of door request switch (driver side).
REQ SW-AS	Indicates [ON/OFF] condition of door request switch (passenger side).
REQ SW-BD/TR	Indicates [ON/OFF] condition of trunk opener request switch.
PUSH SW	Indicates [ON/OFF] condition of push-button ignition switch
UNLK SEN-DR	Indicates [ON/OFF] condition of driver door UNLOCK status.
KEY SW -SLOT	Indicates [ON/OFF] condition of key slot.
DOOR SW-DR	Indicates [ON/OFF] condition of front door switch LH.
DOOR SW-AS	Indicates [ON/OFF] condition of front door switch RH.
DOOR SW-RR	Indicates [ON/OFF] condition of rear door switch RH.
DOOR SW-RL	Indicates [ON/OFF] condition of rear door switch LH.
DOOR SW-BK	This is displayed even when it is not equipped.
CDL LOCK SW	Indicates [ON/OFF] condition of lock signal from door lock/unlock switch LH and RH.
CDL UNLOCK SW	Indicates [ON/OFF] condition of unlock signal from door lock/unlock switch LH and RH.
KEY CYL LK-SW	Indicates [ON/OFF] condition of lock signal from front door key cylinder switch.
KEY CYL UN-SW	Indicates [ON/OFF] condition of unlock signal from front door key cylinder switch.
KEY CYL SW-TR	This is displayed even when it is not equipped.
TR/BD OPEN SW	Indicates [ON/OFF] condition of trunk lid opener switch.
TRNK/HAT MNTR	Indicates [ON/OFF] condition of trunk room lamp switch.
RKE-LOCK	Indicates [ON/OFF] condition of LOCK signal from Intelligent Key.
RKE-UNLOCK	Indicates [ON/OFF] condition of UNLOCK signal from Intelligent Key.
RKE-TR/BD	Indicates [ON/OFF] condition of TRUNK OPEN signal from Intelligent Key.

WORK SUPPORT

Test Item	Description
SECURITY ALARM SET	This mode is able to confirm and change security alarm ON-OFF setting.
THEFT ALM TRG	The switch which triggered vehicle security alarm is recorded. This mode is able to confirm and erase the record of vehicle security alarm. The trigger data can be erased by touching "CLEAR" on CONSULT screen.

ACTIVE TEST

Test Item	Description
THEFT IND	This test is able to check security indicator lamp operation. The lamp will be turned on when "ON" on CONSULT screen is touched.
VEHICLE SECURITY HORN	This test is able to check vehicle security horn operation. The horns will be activated for 0.5 seconds after "ON" on CONSULT screen is touched.

DIAGNOSIS SYSTEM (BCM)

< SYSTEM DESCRIPTION >

Test Item	Description
HEADLAMP(HI)	This test is able to check vehicle security lamp operation. The headlamps will be activated for 0.5 seconds after "ON" on CONSULT screen is touched.
FLASHER	This test is able to check vehicle security hazard lamp operation. The hazard lamps will be activated after "ON" on CONSULT screen is touched.

IMMU

IMMU : CONSULT Function (BCM - IMMU)

INFOID:000000007467159

DATA MONITOR

Monitor item	Content
CONFIRM ID ALL	Indicates [YET] at all time. Switch to [DONE] when a registered Intelligent Key is inserted into the key slot.
CONFIRM ID4	
CONFIRM ID3	
CONFIRM ID2	
CONFIRM ID1	
TP 4	Indicates the number of ID which has been registered.
TP 3	
TP 2	
TP 1	
PUSH SW	Indicates [ON/OFF] condition of push-button ignition switch.
KEY SW -SLOT	Indicates [ON/OFF] condition of key slot.

ACTIVE TEST

Test item	Description
THEFT IND	This test is able to check security indicator lamp operation. The lamp will be turned on when "ON" on CONSULT screen touched.

A
B
C
D
E
F
G
H
I
J
L
M
N
O
P

SEC

U1000 CAN COMM CIRCUIT

< DTC/CIRCUIT DIAGNOSIS >

DTC/CIRCUIT DIAGNOSIS

U1000 CAN COMM CIRCUIT

BCM

BCM : Description

INFOID:000000007467160

CAN (Controller Area Network) is a serial communication line for real time applications. It is an on-vehicle multiplex communication line with high data communication speed and excellent error detection ability. Modern vehicle is equipped with many electronic control unit, and each control unit shares information and links with other control units during operation (not independent). In CAN communication, control units are connected with 2 communication lines (CAN H-line, CAN L-line) allowing a high rate of information transmission with less wiring. Each control unit transmits/receives data but selectively reads required data only. CAN Communication Signal Chart. Refer to [LAN-26, "CAN Communication Signal Chart"](#).

BCM : DTC Logic

INFOID:000000007467161

DTC DETECTION LOGIC

DTC	CONSULT display description	DTC Detection Condition	Possible cause
U1000	CAN COMM	When BCM cannot communicate CAN communication signal continuously for 2 seconds or more.	CAN communication system

BCM : Diagnosis Procedure

INFOID:000000007467162

1. PERFORM SELF DIAGNOSTIC

1. Turn ignition switch ON and wait for 2 seconds or more.
2. Check "Self Diagnostic Result".

Is DTC "U1000" displayed?

- YES >> Refer to [LAN-17, "Trouble Diagnosis Flow Chart"](#).
NO >> Refer to [GI-43, "Intermittent Incident"](#).

IPDM E/R

IPDM E/R : Description

INFOID:000000007467163

CAN (Controller Area Network) is a serial communication line for real time applications. It is an on-vehicle multiplex communication line with high data communication speed and excellent error detection ability. Modern vehicle is equipped with many electronic control unit, and each control unit shares information and links with other control units during operation (not independent). In CAN communication, control units are connected with 2 communication lines (CAN-H line, CAN-L line) allowing a high rate of information transmission with less wiring. Each control unit transmits/receives data but selectively reads required data only. CAN Communication Signal Chart. Refer to [LAN-9, "CAN Communication Control Circuit"](#).

IPDM E/R : DTC Logic

INFOID:000000007467164

DTC DETECTION LOGIC

DTC	CONSULT display description	DTC Detection Condition	Possible cause
U1000	CAN COMM CIRCUIT	When IPDM E/R cannot communicate CAN communication signal continuously for 2 seconds or more	In CAN communication system, any item (or items) of the following listed below is malfunctioning. <ul style="list-style-type: none">• Transmission• Receiving (ECM)• Receiving (BCM)• Receiving (Unified meter and A/C amp.)

DTC CONFIRMATION PROCEDURE

U1000 CAN COMM CIRCUIT

< DTC/CIRCUIT DIAGNOSIS >

IPDM E/R : Diagnosis Procedure

INFOID:000000007467165

1. PERFORM SELF DIAGNOSTIC

1. Turn the ignition switch ON and wait for 2 seconds or more.
2. Check "Self Diagnostic Result" of IPDM E/R.

Is DTC "U1000" displayed?

- YES >> Refer to [LAN-17, "Trouble Diagnosis Flow Chart"](#).
NO >> Refer to [GI-43, "Intermittent Incident"](#).

A
B
C
D
E
F
G
H
I
J
L
M
N
O
P

SEC

U1010 CONTROL UNIT (CAN)

< DTC/CIRCUIT DIAGNOSIS >

U1010 CONTROL UNIT (CAN)

BCM

BCM : DTC Logic

INFOID:000000007467166

DTC DETECTION LOGIC

DTC	CONSULT display de- scription	DTC Detection Condition	Possible cause
U1010	CONTROL UNIT(CAN)	BCM detected internal CAN communication circuit malfunction.	BCM

BCM : Diagnosis Procedure

INFOID:000000007467167

1.REPLACE BCM

When DTC "U1010" is detected, replace BCM.

>> Replace BCM. Refer to [BCS-80. "Exploded View"](#).

P1610 LOCK MODE

< DTC/CIRCUIT DIAGNOSIS >

P1610 LOCK MODE

Description

INFOID:000000007467168

When the starting operation is carried more than five times consecutively under the following conditions, NATS shifts to the mode that prevents the engine from being started.

- Unregistered Intelligent Key is used.
- BCM or ECM is malfunctioning.

DTC Logic

INFOID:000000007467169

DTC DETECTION LOGIC

DTC No.	Trouble diagnosis name	DTC detecting condition	Possible cause
P1610	LOCK MODE	When the starting operation is carried out five or more times consecutively under the following conditions. <ul style="list-style-type: none">• Unregistered Intelligent Key• BCM or ECM is malfunctioning	—

DTC CONFIRMATION PROCEDURE

1. PERFORM DTC CONFIRMATION PROCEDURE

1. Turn ignition switch ON.
2. Check "Self-diagnostic result" using CONSULT.

Is DTC detected?

- YES >> Go to [SEC-35. "Diagnosis Procedure"](#).
NO >> INSPECTION END

Diagnosis Procedure

INFOID:000000007467170

1. CHECK ENGINE START FUNCTION

1. Perform the check for DTC except DTC P1610.
2. Use CONSULT to erase DTC after fixing.
3. Turn ignition switch OFF.
4. Turn ignition switch ON when registered Intelligent Key is inserted into key slot and wait for 5 seconds.
5. Turn the ignition switch OFF and wait 5 seconds.
6. Repeat steps 4 and 5 twice (a total of 3 times).
7. Check that engine can start when registered Intelligent Key is inserted into key slot.

>> INSPECTION END

A
B
C
D
E
F
G
H
I
J
L
M
N
O
P

SEC

P1611 ID DISCORD, IMMUECM

< DTC/CIRCUIT DIAGNOSIS >

P1611 ID DISCORD, IMMUECM

Description

INFOID:000000007467171

BCM performs the ID verification with ECM that allows the engine to start. Start the engine if the ID is successfully verified. ECM prevents the engine from starting if the ID is not registered. BCM starts the communication with ECM if ignition switch is turned ON.

DTC Logic

INFOID:000000007467172

DTC DETECTION LOGIC

NOTE:

- If DTC P1611 is displayed with DTC U1000, first perform the trouble diagnosis for DTC U1000. Refer to [SEC-32, "BCM : DTC Logic"](#).
- If DTC P1611 is displayed with DTC U1010, first perform the trouble diagnosis for DTC U1010. Refer to [SEC-34, "BCM : DTC Logic"](#).

DTC No.	Trouble diagnosis name	DTC detecting condition	Possible cause
P1611	ID DISCORD, IMMUECM	The ID verification results between BCM and ECM are NG. Registration is necessary.	<ul style="list-style-type: none">• BCM• ECM

DTC CONFIRMATION PROCEDURE

1.PERFORM DTC CONFIRMATION PROCEDURE

1. Turn ignition switch ON under the following conditions.

A/T models

- Selector lever is in the P or N position
- Do not depress brake pedal

M/T models

- Do not depress clutch pedal
2. Check "Self-diagnostic result" using CONSULT.

Is DTC detected?

- YES >> Go to [SEC-36, "Diagnosis Procedure"](#).
NO >> INSPECTION END

Diagnosis Procedure

INFOID:000000007467173

1.PERFORM INITIALIZATION

Perform initialization using CONSULT. Register all Intelligent Keys.
For initialization and registration of Intelligent Key, follow the instruction of CONSULT display.

Can the system be initialized and can the engine be started with registered Intelligent Key?

- YES >> INSPECTION END
NO >> GO TO 2.

2.REPLACE BCM

1. Replace BCM. Refer to [BCS-80, "Removal and Installation"](#).
2. Perform initialization using CONSULT.
For initialization, follow the instruction of CONSULT display.

Can the system be initialized and can the engine be started with registered Intelligent Key?

- YES >> INSPECTION END
NO >> GO TO 3.

3.REPLACE ECM

1. Replace ECM. Refer to the following.
 - VQ37 engine models: [EC-32, "ADDITIONAL SERVICE WHEN REPLACING CONTROL UNIT \(ECM\) : Description"](#)

P1611 ID DISCORD, IMMU-ECM

< DTC/CIRCUIT DIAGNOSIS >

- VQ25 engine models (except for Mexico): [EC-634. "ADDITIONAL SERVICE WHEN REPLACING CONTROL UNIT \(ECM\) : Description"](#)
 - VQ25 engine models (for Mexico): [EC-1177. "ADDITIONAL SERVICE WHEN REPLACING CONTROL UNIT \(ECM\) : Description"](#)
2. Perform initialization using CONSULT.
For initialization, follow the instruction of CONSULT display.

Can the system be initialized and can the engine be started with registered Intelligent Key?

YES >> INSPECTION END

NO >> GO TO 4.

4. CHECK INTERMITTENT INCIDENT

Refer to [GI-43. "Intermittent Incident"](#).

>> INSPECTION END

A
B
C
D
E
F
G
H
I
J
L
M
N
O
P

SEC

P1612 CHAIN OF ECM-IMMU

< DTC/CIRCUIT DIAGNOSIS >

P1612 CHAIN OF ECM-IMMU

Description

INFOID:000000007467174

BCM performs ID verification with ECM that allows the engine to start. Start the engine if the ID is successfully verified. ECM prevents the engine from starting if the ID is not registered. BCM starts the communication with ECM if ignition switch is turned ON.

DTC Logic

INFOID:000000007467175

DTC DETECTION LOGIC

NOTE:

- If DTC P1612 is displayed with DTC U1000, first perform the trouble diagnosis for DTC U1000. Refer to [SEC-32, "BCM : DTC Logic"](#).
- If DTC P1612 is displayed with DTC U1010, first perform the trouble diagnosis for DTC U1010. Refer to [SEC-34, "BCM : DTC Logic"](#).

DTC No.	Trouble diagnosis name	DTC detecting condition	Possible cause
P1612	CHAIN OF ECM-IMMU	Inactive communication between ECM and BCM	<ul style="list-style-type: none">• Harness or connectors (The CAN communication line is open or shorted)• BCM• ECM

DTC CONFIRMATION PROCEDURE

1. PERFORM DTC CONFIRMATION PROCEDURE

1. Turn ignition switch ON under the following conditions.

A/T models

- Selector lever is in the P or N position
- Do not depress brake pedal

M/T models

- Do not depress clutch pedal
2. Check "Self-diagnostic result" using CONSULT.

Is DTC detected?

- YES >> Go to [SEC-38, "Diagnosis Procedure"](#).
NO >> INSPECTION END

Diagnosis Procedure

INFOID:000000007467176

1. REPLACE BCM

1. Replace BCM. Refer to [BCS-80, "Removal and Installation"](#).
2. Perform initialization using CONSULT.
For initialization, follow the instruction of CONSULT display.

Does the engine start?

- YES >> INSPECTION END
NO >> GO TO 2.

2. REPLACE ECM

Replace ECM. Refer to the following.

- VQ37 engine models: [EC-32, "ADDITIONAL SERVICE WHEN REPLACING CONTROL UNIT \(ECM\) : Description"](#)
- VQ25 engine models (except for Mexico): [EC-634, "ADDITIONAL SERVICE WHEN REPLACING CONTROL UNIT \(ECM\) : Description"](#)
- VQ25 engine models (for Mexico): [EC-1177, "ADDITIONAL SERVICE WHEN REPLACING CONTROL UNIT \(ECM\) : Description"](#)

P1612 CHAIN OF ECM-IMMU

< DTC/CIRCUIT DIAGNOSIS >

>> INSPECTION END

A

B

C

D

E

F

G

H

I

J

SEC

L

M

N

O

P

P1614 CHAIN OF IMMU-KEY

< DTC/CIRCUIT DIAGNOSIS >

P1614 CHAIN OF IMMU-KEY

Description

INFOID:000000007467177

Performs ID verification through BCM and Intelligent Key when push-button ignition switch is pressed. Prohibits start of engine when an unregistered ID of Intelligent Key is used.

DTC Logic

INFOID:000000007467178

DTC DETECTION LOGIC

DTC No.	Trouble diagnosis name	DTC detecting condition	Possible cause
P1614	CHAIN OF IMMU-KEY	Inactive communication between key slot and BCM.	<ul style="list-style-type: none">• Harness or connectors (The key slot circuit is open or shorted)• Key slot• BCM

DTC CONFIRMATION PROCEDURE

1. PERFORM DTC CONFIRMATION PROCEDURE 1

1. Insert Intelligent Key into the key slot.
2. Check "Self-diagnostic result" using CONSULT.

Is DTC detected?

- YES >> Go to [SEC-40, "Diagnosis Procedure"](#).
NO >> GO TO 2.

2. PERFORM DTC CONFIRMATION PROCEDURE 2

1. Press the push-button ignition switch.
2. Check "Self-diagnostic result" using CONSULT.

Is DTC detected?

- YES >> Go to [SEC-40, "Diagnosis Procedure"](#).
NO >> INSPECTION END

Diagnosis Procedure

INFOID:000000007467179

1. INSPECTION START

Perform inspection in accordance with procedure that confirms DTC.

Which procedure confirms DTC?

- DTC confirmation procedure 1 >> GO TO 2.
DTC confirmation procedure 2 >> GO TO 4.

2. CHECK KEY SLOT INPUT SIGNAL

1. Turn ignition switch OFF.
2. Disconnect key slot connector.
3. Check voltage between key slot harness connector and ground.

(+)		(-)	Voltage (V) (Approx.)
Key slot			
Connector	Terminal		
M22	2	Ground	Battery voltage

Is the inspection result normal?

- YES >> Replace key slot. Refer to [SEC-162, "Removal and Installation"](#).
NO >> GO TO 3.

3. CHECK KEY SLOT CIRCUIT

P1614 CHAIN OF IMMU-KEY

< DTC/CIRCUIT DIAGNOSIS >

1. Disconnect BCM connector.
2. Check continuity between key slot harness connector and BCM harness connector.

Key slot		BCM		Continuity
Connector	Terminal	Connector	Terminal	
M22	2	M122	80	Existed

3. Check continuity between key slot harness connector and ground.

Key slot		Ground	Continuity
Connector	Terminal		
M22	2		Not existed

Is the inspection result normal?

- YES >> Replace BCM. Refer to [BCS-80, "Removal and Installation"](#).
 NO >> Repair or replace harness.

4.CHECK PUSH-BUTTON IGNITION SWITCH OPERATION

Press push-button ignition switch and check if it turns ON.

Does ignition switch turn to ON?

- YES >> GO TO 5.
 NO >> GO TO 7.

5.CHECK KEY SLOT COMMUNICATION SIGNAL

1. Turn ignition switch OFF.
2. Disconnect key slot connector.
3. Check voltage between key slot harness connector and ground.

Key slot (+)		Ground (-)	Voltage (V) (Approx.)
Connector	Terminal		
M22	3	Ground	Battery voltage

Is the inspection result normal?

- YES >> Replace key slot. Refer to [SEC-162, "Removal and Installation"](#).
 NO >> GO TO 6.

6.CHECK KEY SLOT COMMUNICATION SIGNAL CIRCUIT

1. Disconnect BCM connector.
2. Check continuity between key slot harness connector and BCM harness connector.

Key slot		BCM		Continuity
Connector	Terminal	Connector	Terminal	
M22	3	M122	81	Existed

3. Check continuity between key slot harness connector and ground.

Key slot		Ground	Continuity
Connector	Terminal		
M22	3		Not existed

Is the inspection result normal?

- YES >> Replace BCM. Refer to [BCS-80, "Removal and Installation"](#).
 NO >> Repair or replace harness.

7.CHECK KEY SLOT GROUND CIRCUIT

1. Turn ignition switch OFF.
2. Disconnect key slot connector.

A
B
C
D
E
F
G
H
I
J
L
M
N
O
P

SEC

P1614 CHAIN OF IMMU-KEY

< DTC/CIRCUIT DIAGNOSIS >

3. Check continuity between key slot harness connector and ground.

Key slot		Ground	Continuity
Connector	Terminal		
M22	7		Existed

Is the inspection result normal?

YES >> GO TO 8.

NO >> Repair or replace harness.

8.CHECK INTERMITTENT INCIDENT

Refer to [GI-43, "Intermittent Incident"](#).

>> INSPECTION END

P1615 DIFFERENCE OF KEY

< DTC/CIRCUIT DIAGNOSIS >

P1615 DIFFERENCE OF KEY

Description

INFOID:000000007467180

Performs ID verification through BCM and Intelligent Key when push-button ignition switch is pressed. Prohibits start of engine when an unregistered ID of Intelligent Key is used.

DTC Logic

INFOID:000000007467181

DTC DETECTION LOGIC

DTC No.	Trouble diagnosis name	DTC detecting condition	Possible cause
P1615	DIFFERENCE OF KEY	The ID verification results between BCM and Intelligent Key are NG. Registration is necessary.	Intelligent Key

DTC CONFIRMATION PROCEDURE

1.PERFORM DTC CONFIRMATION PROCEDURE

1. Press the push-button ignition switch.
2. Check "Self-diagnostic result" using CONSULT.

Is DTC detected?

- YES >> Go to [SEC-43, "Diagnosis Procedure"](#).
NO >> INSPECTION END

Diagnosis Procedure

INFOID:000000007467182

1.PERFORM INITIALIZATION

Perform initialization using CONSULT. Register all Intelligent Keys. For initialization and registration of Intelligent Key, follow the instruction of CONSULT display.

Can the system be initialized and can the engine be started with registered Intelligent Key?

- YES >> INSPECTION END
NO >> GO TO 2.

2.REPLACE INTELLIGENT KEY

1. Replace Intelligent Key.
2. Perform initialization using CONSULT.
For initialization and registration of Intelligent Key, follow the instruction of CONSULT display.

Can the system be initialized and can the engine be started with registered Intelligent Key?

- YES >> INSPECTION END
NO >> GO TO 3.

3.CHECK INTERMITTENT INCIDENT

Refer to [GI-43, "Intermittent Incident"](#).

>> INSPECTION END

A
B
C
D
E
F
G
H
I
J
L
M
N
O
P

SEC

B2190 NATS ANTENNA AMP.

< DTC/CIRCUIT DIAGNOSIS >

B2190 NATS ANTENNA AMP.

Description

INFOID:000000007467183

Performs ID verification through BCM and Intelligent Key when push-button ignition switch is pressed. Prohibits start of engine when an unregistered ID of Intelligent Key is used.

DTC Logic

INFOID:000000007467184

DTC DETECTION LOGIC

DTC No.	Trouble diagnosis name	DTC detecting condition	Possible cause
B2190	NATS ANTENNA AMP	Inactive communication between key slot and BCM.	<ul style="list-style-type: none">• Harness or connectors (The key slot circuit is open or shorted)• Key slot• BCM

DTC CONFIRMATION PROCEDURE

1.PERFORM DTC CONFIRMATION PROCEDURE 1

1. Insert Intelligent Key into the key slot.
2. Check "Self-diagnostic result" using CONSULT.

Is DTC detected?

- YES >> Go to [SEC-44, "Diagnosis Procedure"](#).
NO >> GO TO 2.

2.PERFORM DTC CONFIRMATION PROCEDURE 2

1. Press the push-button ignition switch.
2. Check "Self-diagnostic result" using CONSULT.

Is DTC detected?

- YES >> Go to [SEC-44, "Diagnosis Procedure"](#).
NO >> INSPECTION END

Diagnosis Procedure

INFOID:000000007467185

1. INSPECTION START

Perform inspection in accordance with the appropriate confirmation procedure DTC.

Which procedure confirms DTC?

- DTC confirmation procedure 1>>GO TO 2.
DTC confirmation procedure 2>>GO TO 4.

2.CHECK KEY SLOT INPUT SIGNAL

1. Turn ignition switch OFF.
2. Disconnect key slot connector.
3. Check voltage between key slot harness connector and ground.

(+)		(-)	Voltage (V) (Approx.)
Key slot			
Connector	Terminal		
M22	2	Ground	Battery voltage

Is the inspection result normal?

- YES >> Replace key slot. Refer to [SEC-162, "Removal and Installation"](#).
NO >> GO TO 3.

3.CHECK KEY SLOT CIRCUIT

B2190 NATS ANTENNA AMP.

< DTC/CIRCUIT DIAGNOSIS >

1. Disconnect BCM connector.
2. Check continuity between key slot harness connector and BCM harness connector.

Key slot		BCM		Continuity
Connector	Terminal	Connector	Terminal	
M22	2	M122	80	Existed

3. Check continuity between key slot harness connector and ground.

Key slot		Ground	Continuity
Connector	Terminal		
M22	2		Not existed

Is the inspection result normal?

- YES >> Replace BCM. Refer to [BCS-80, "Removal and Installation"](#).
 NO >> Repair or replace harness.

4. CHECK PUSH-BUTTON IGNITION SWITCH OPERATION

Press push-button ignition switch and check if it turns ON.

Does ignition switch turn to ON?

- YES >> GO TO 5.
 NO >> GO TO 7.

5. CHECK KEY SLOT COMMUNICATION SIGNAL

1. Turn ignition switch OFF.
2. Disconnect key slot connector.
3. Check voltage between key slot harness connector and ground.

Key slot (+)		Ground (-)	Voltage (V) (Approx.)
Connector	Terminal		
M22	3	Ground	Battery voltage

Is the inspection result normal?

- YES >> Replace key slot. Refer to [SEC-162, "Removal and Installation"](#).
 NO >> GO TO 6.

6. CHECK KEY SLOT COMMUNICATION SIGNAL CIRCUIT

1. Disconnect BCM connector.
2. Check continuity between key slot harness connector and BCM harness connector.

Key slot		BCM		Continuity
Connector	Terminal	Connector	Terminal	
M22	3	M122	81	Existed

3. Check continuity between key slot harness connector and ground.

Key slot		Ground	Continuity
Connector	Terminal		
M22	3		Not existed

Is the inspection result normal?

- YES >> Replace BCM. Refer to [BCS-80, "Removal and Installation"](#).
 NO >> Repair or replace harness.

7. CHECK KEY SLOT GROUND CIRCUIT

1. Turn ignition switch OFF.
2. Disconnect key slot connector.

A
B
C
D
E
F
G
H
I
J
L
M
N
O
P

SEC

B2190 NATS ANTENNA AMP.

< DTC/CIRCUIT DIAGNOSIS >

3. Check continuity between key slot harness connector and ground.

Key slot		Ground	Continuity
Connector	Terminal		
M22	7		Existed

Is the inspection result normal?

YES >> GO TO 8.

NO >> Repair or replace harness.

8.CHECK INTERMITTENT INCIDENT

Refer to [GI-43, "Intermittent Incident"](#).

>> INSPECTION END

B2191 DIFFERENCE OF KEY

< DTC/CIRCUIT DIAGNOSIS >

B2191 DIFFERENCE OF KEY

Description

INFOID:000000007467186

Performs ID verification through BCM and Intelligent Key when push-button ignition switch is pressed. Prohibits start of engine when an unregistered ID of Intelligent Key is used.

DTC Logic

INFOID:000000007467187

DTC DETECTION LOGIC

DTC No.	Trouble diagnosis name	DTC detecting condition	Possible cause
B2191	DIFFERENCE OF KEY	The ID verification results between BCM and Intelligent Key are NG. Registration is necessary.	Intelligent Key

DTC CONFIRMATION PROCEDURE

1.PERFORM DTC CONFIRMATION PROCEDURE

1. Press the push-button ignition switch.
2. Check "Self-diagnostic result" using CONSULT.

Is DTC detected?

- YES >> Go to [SEC-47, "Diagnosis Procedure"](#).
NO >> INSPECTION END

Diagnosis Procedure

INFOID:000000007467188

1.PERFORM INITIALIZATION

Perform initialization using CONSULT. Register all Intelligent Keys. For initialization and registration of Intelligent Key, follow the instruction of CONSULT display.

Can the system be initialized and can the engine be started with registered Intelligent Key?

- YES >> INSPECTION END
NO >> GO TO 2.

2.REPLACE INTELLIGENT KEY

1. Replace Intelligent Key.
2. Perform initialization using CONSULT.
For initialization and registration of Intelligent Key, follow the instruction of CONSULT display.

Can the system be initialized and can the engine be started with registered Intelligent Key?

- YES >> INSPECTION END
NO >> GO TO 3.

3.CHECK INTERMITTENT INCIDENT

Refer to [GI-43, "Intermittent Incident"](#).

>> INSPECTION END

A
B
C
D
E
F
G
H
I
J
L
M
N
O
P

SEC

B2192 ID DISCORD, IMMUECM

< DTC/CIRCUIT DIAGNOSIS >

B2192 ID DISCORD, IMMUECM

Description

INFOID:000000007467189

BCM performs ID verification with ECM that allows the engine to start. Start the engine if the ID is successfully verified. ECM prevents the engine from starting if the ID is not registered. BCM starts the communication with ECM if ignition switch is turned ON.

DTC Logic

INFOID:000000007467190

DTC DETECTION LOGIC

NOTE:

- If DTC B2192 is displayed with DTC U1000, first perform the trouble diagnosis for DTC U1000. Refer to [SEC-32, "BCM : DTC Logic"](#).
- If DTC B2192 is displayed with DTC U1010, first perform the trouble diagnosis for DTC U1010. Refer to [SEC-34, "BCM : DTC Logic"](#).

DTC No.	Trouble diagnosis name	DTC detecting condition	Possible cause
B2192	ID DISCORD, IMMUECM	The ID verification results between BCM and ECM are NG. Registration is necessary.	<ul style="list-style-type: none">• BCM• ECM

DTC CONFIRMATION PROCEDURE

1. PERFORM DTC CONFIRMATION PROCEDURE

1. Turn ignition switch ON under the following conditions.

A/T models

- Selector lever is in the P or N position
- Do not depress brake pedal

M/T models

- Do not depress clutch pedal
2. Check "Self-diagnostic result" using CONSULT.

Is DTC detected?

- YES >> Go to [SEC-48, "Diagnosis Procedure"](#).
NO >> INSPECTION END

Diagnosis Procedure

INFOID:000000007467191

1. PERFORM INITIALIZATION

Perform initialization using CONSULT. Register all Intelligent Keys.
For initialization and registration of Intelligent Key, follow the instruction of CONSULT display.

Can the system be initialized and can the engine be started with registered Intelligent Key?

- YES >> INSPECTION END
NO >> GO TO 2.

2. REPLACE BCM

1. Replace BCM. Refer to [BCS-80, "Removal and Installation"](#).
2. Perform initialization using CONSULT.
For initialization, follow the instruction of CONSULT display.

Can the system be initialized and can the engine be started with registered Intelligent Key?

- YES >> INSPECTION END
NO >> GO TO 3.

3. REPLACE ECM

1. Replace ECM. Refer to the following.
 - VQ37 engine models: [EC-32, "ADDITIONAL SERVICE WHEN REPLACING CONTROL UNIT \(ECM\) : Description"](#)

B2192 ID DISCORD, IMMUECM

< DTC/CIRCUIT DIAGNOSIS >

- VQ25 engine models (except for Mexico): [EC-634. "ADDITIONAL SERVICE WHEN REPLACING CONTROL UNIT \(ECM\) : Description"](#)
 - VQ25 engine models (for Mexico): [EC-1177. "ADDITIONAL SERVICE WHEN REPLACING CONTROL UNIT \(ECM\) : Description"](#)
2. Perform initialization using CONSULT.
For initialization, follow the instruction of CONSULT display.

Can the system be initialized and can the engine be started with registered Intelligent Key?

YES >> INSPECTION END

NO >> GO TO 4.

4. CHECK INTERMITTENT INCIDENT

Refer to [GI-43. "Intermittent Incident"](#).

>> INSPECTION END

A
B
C
D
E
F
G
H
I
J
L
M
N
O
P

SEC

B2193 CHAIN OF ECM-IMMU

< DTC/CIRCUIT DIAGNOSIS >

B2193 CHAIN OF ECM-IMMU

Description

INFOID:000000007467192

BCM performs the ID verification with ECM that allows the engine to start. Start the engine if the ID is successfully verified. ECM prevents the engine from starting if the ID is not registered. BCM starts the communication with ECM if ignition switch is turned ON.

DTC Logic

INFOID:000000007467193

DTC DETECTION LOGIC

NOTE:

- If DTC B2193 is displayed with DTC U1000, first perform the trouble diagnosis for DTC U1000. Refer to [SEC-32, "BCM : DTC Logic"](#).
- If DTC B2193 is displayed with DTC U1010, first perform the trouble diagnosis for DTC U1010. Refer to [SEC-34, "BCM : DTC Logic"](#).

DTC No.	Trouble diagnosis name	DTC detecting condition	Possible cause
B2193	CHAIN OF ECM-IMMU	Inactive communication between ECM and BCM	<ul style="list-style-type: none">• Harness or connectors (The CAN communication line is open or shorted)• BCM• ECM

DTC CONFIRMATION PROCEDURE

1.PERFORM DTC CONFIRMATION PROCEDURE

1. Turn ignition switch ON under the following conditions.

A/T models

- Selector lever is in the P or N position
- Do not depress brake pedal

M/T models

- Do not depress clutch pedal
2. Check "Self-diagnostic result" using CONSULT.

Is DTC detected?

- YES >> Go to [SEC-50, "Diagnosis Procedure"](#).
NO >> INSPECTION END

Diagnosis Procedure

INFOID:000000007467194

1.REPLACE BCM

1. Replace BCM. Refer to [BCS-80, "Removal and Installation"](#).
2. Perform initialization using CONSULT.
For initialization, follow the instruction of CONSULT display.

Does the engine start?

- YES >> INSPECTION END
NO >> GO TO 2.

2.REPLACE ECM

Replace ECM. Refer to the following.

- VQ37 engine models: [EC-32, "ADDITIONAL SERVICE WHEN REPLACING CONTROL UNIT \(ECM\) : Description"](#)
- VQ25 engine models (except for Mexico): [EC-634, "ADDITIONAL SERVICE WHEN REPLACING CONTROL UNIT \(ECM\) : Description"](#)
- VQ25 engine models (for Mexico): [EC-1177, "ADDITIONAL SERVICE WHEN REPLACING CONTROL UNIT \(ECM\) : Description"](#)

>> INSPECTION END

B2195 ANTI-SCANNING

< DTC/CIRCUIT DIAGNOSIS >

B2195 ANTI-SCANNING

Description

INFOID:000000007467195

When ignition switch is turned ON, BCM performs ID verification with ECM. If ID verification that is out of the specified specification is detected, BCM prohibits further ID verification and engine cranking.

DTC Logic

INFOID:000000007467196

DTC DETECTION LOGIC

DTC No.	Trouble diagnosis name	DTC detecting condition	Possible cause
B2195	ANTI-SCANNING	ID verification between BCM and ECM that is out of the specified specification is detected	ID verification request out of the specified specification

DTC CONFIRMATION PROCEDURE

1. PERFORM DTC CONFIRMATION PROCEDURE

1. Turn ignition switch ON under the following conditions.

A/T models

- Selector lever is in the P or N position
- Do not depress brake pedal

M/T models

- Do not depress clutch pedal
2. Check "Self-diagnostic result" using CONSULT.

Is DTC detected?

- YES >> Refer to [SEC-51, "Diagnosis Procedure"](#).
NO >> INSPECTION END.

Diagnosis Procedure

INFOID:000000007467197

1. CHECK SELF-DIAGNOSTIC RESULT-1

1. Perform "Self-diagnostic result" of BCM using CONSULT.
2. Erase DTC.
3. Perform DTC Confirmation Procedure. Refer to [SEC-51, "DTC Logic"](#).

Is DTC 2195 detected?

- YES >> GO TO 2.
NO >> INSPECTION END

2. CHECK EQUIPMENT OF THE VEHICLE

Check that unspecified accessory part related to engine start is not installed.

Is unspecified accessory part related to engine start installed?

- YES >> GO TO 3.
NO >> Replace BCM. Refer to [BCS-80, "Removal and Installation"](#).

3. CHECK SELF-DIAGNOSTIC RESULT-2

1. Obtain the customers approval to remove unspecified accessory part related to engine start, and then remove it.
2. Perform "Self-diagnostic result" of BCM using CONSULT.
3. Erase DTC.
4. Perform DTC Confirmation Procedure. Refer to [SEC-51, "DTC Logic"](#).

Is DTC 2195 detected?

- YES >> Replace BCM. Refer to [BCS-80, "Removal and Installation"](#).
NO >> INSPECTION END

B2555 STOP LAMP

< DTC/CIRCUIT DIAGNOSIS >

B2555 STOP LAMP

Description

INFOID:000000007467204

BCM detects the stop lamp status and confirms the stop lamp switch ON/OFF status. BCM confirms the engine start condition according to the stop lamp switch ON/OFF status.

DTC Logic

INFOID:000000007467205

DTC DETECTION LOGIC

DTC No.	Trouble diagnosis name	DTC detecting condition	Possible cause
B2555	STOP LAMP	BCM makes a comparison between the upper voltage and lower voltage of stop lamp switch. It judges from their values to detect the malfunctioning circuit.	<ul style="list-style-type: none">• Harness or connectors (stop lamp switch circuit is open or shorted)• Stop lamp switch• Fuse

DTC CONFIRMATION PROCEDURE

1. PERFORM DTC CONFIRMATION PROCEDURE

1. Depress the brake pedal and wait 1 second or more.
2. Check "Self-diagnostic result" using CONSULT.

Is DTC detected?

- YES >> Go to [SEC-52, "Diagnosis Procedure"](#).
NO >> INSPECTION END

Diagnosis Procedure

INFOID:000000007467206

1. CHECK STOP LAMP SWITCH INPUT SIGNAL

1. Turn ignition switch OFF.
2. Disconnect BCM connector.
3. Check voltage between BCM harness connector and ground.

(+)		(-)	Voltage (V) (Approx.)
BCM			
Connector	Terminal		
M123	116	Ground	Battery voltage

Is the inspection normal?

- YES >> GO TO 2.
NO-1 >> Check 10 A fuse [No. 7, located in the fuse block (J/B)].
NO-2 >> Check harness for open or short between BCM and fuse.

2. CHECK STOP LAMP SWITCH POWER SUPPLY CIRCUIT

1. Disconnect stop lamp switch connector.
2. Check voltage between stop lamp harness connector and ground.

(+)		(-)	Voltage (V) (Approx.)
Stop lamp switch			
Connector	Terminal		
E110 (With ICC) E119 (Without ICC)	1	Ground	Battery voltage

Is the inspection result normal?

- YES >> GO TO 3.
NO >> Check harness for open or short to stop lamp switch.

B2555 STOP LAMP

< DTC/CIRCUIT DIAGNOSIS >

3.CHECK STOP LAMP SWITCH CIRCUIT

1. Check continuity between stop lamp switch harness connector and BCM harness connector.

Stop lamp switch		BCM		Continuity
Connector	Terminal	Connector	Terminal	
E110 (With ICC) E119 (Without ICC)	2	M123	118	Existed

2. Check continuity between stop lamp switch harness connector and ground.

Stop lamp switch		Ground	Continuity
Connector	Terminal		
E110 (With ICC) E119 (Without ICC)	2		Not existed

Is the inspection result normal?

YES >> GO TO 4.

NO >> Repair or replace harness.

4.CHECK STOP LAMP SWITCH

Refer to [SEC-53, "Component Inspection"](#).

Is the inspection result normal?

YES >> GO TO 5.

NO >> Replace stop lamp switch. Refer to [BR-18, "Exploded View"](#).

5.CHECK INTERMITTENT INCIDENT

Refer to [GI-43, "Intermittent Incident"](#).

>> INSPECTION END

Component Inspection

INFOID:000000007467207

1.CHECK STOP LAMP SWITCH

1. Turn ignition switch OFF.
2. Disconnect stop lamp switch connector.
3. Check continuity between stop lamp switch terminals.

Stop lamp switch		Condition	Continuity	
Terminal				
1	2	Brake pedal	Not depressed	Not existed
			Depressed	Existed

Is the inspection result normal?

YES >> INSPECTION END

NO >> Replace stop lamp switch. Refer to [BR-18, "Exploded View"](#).

A
B
C
D
E
F
G
H
I
J
L
M
N
O
P

SEC

B2556 PUSH-BUTTON IGNITION SWITCH

< DTC/CIRCUIT DIAGNOSIS >

B2556 PUSH-BUTTON IGNITION SWITCH

Description

INFOID:000000007467208

The switch changes the power supply position. BCM maintains the power supply position status. BCM changes the power supply position with the operation of the push-button ignition switch.

DTC Logic

INFOID:000000007467209

DTC DETECTION LOGIC

DTC No.	Trouble diagnosis name	DTC detecting condition	Possible cause
B2556	PUSH-BUTTON IGNITION SWITCH	BCM detects the push-button ignition switch stuck at ON for 100 seconds or more.	<ul style="list-style-type: none">• Harness or connectors (Push-button ignition switch circuit is shorted.)• Push-button ignition switch• BCM

DTC CONFIRMATION PROCEDURE

1. PERFORM DTC CONFIRMATION PROCEDURE

1. Start the engine and wait 100 seconds or more.
2. Check "Self-diagnostic result" using CONSULT.

Is DTC detected?

- YES >> Go to [SEC-54, "Diagnosis Procedure"](#).
NO >> INSPECTION END

Diagnosis Procedure

INFOID:000000007467210

1. CHECK PUSH-BUTTON IGNITION SWITCH INPUT SIGNAL

1. Turn ignition switch OFF.
2. Disconnect push-button ignition switch connector.
3. Check voltage between push-button ignition switch harness connector and ground.

(+)		(-)	Voltage (V) (Approx.)
Connector	Terminal		
M50	4	Ground	Battery voltage

Is the inspection result normal?

- YES >> GO TO 3.
NO >> GO TO 2.

2. CHECK PUSH-BUTTON IGNITION SWITCH CIRCUIT

1. Disconnect BCM connector and IPDM E/R connector.
2. Check continuity between push-button ignition switch harness connector and BCM harness connector.

Push-button ignition switch		BCM		Continuity
Connector	Terminal	Connector	Terminal	
M50	4	M122	60	Existed

3. Check continuity between push-button ignition switch harness connector and ground.

Push-button ignition switch		Ground	Continuity
Connector	Terminal		
M50	4		Not existed

Is the inspection result normal?

B2556 PUSH-BUTTON IGNITION SWITCH

< DTC/CIRCUIT DIAGNOSIS >

- YES >> Replace BCM. Refer to [BCS-80. "Removal and Installation"](#).
 NO >> Repair or replace harness.

3.CHECK PUSH-BUTTON IGNITION SWITCH GROUND CIRCUIT

Check continuity between push-button ignition switch harness connector and ground.

Push-button ignition switch		Ground	Continuity
Connector	Terminal		Existed
M50	1		Existed

Is the inspection result normal?

- YES >> GO TO 4.
 NO >> Repair or replace harness.

4.CHECK PUSH-BUTTON IGNITION SWITCH

Refer to [SEC-55. "Component Inspection"](#).

Is the inspection result normal?

- YES >> GO TO 5.
 NO >> Replace push-button ignition switch. Refer to [SEC-163. "Removal and Installation"](#).

5.CHECK INTERMITTENT INCIDENT

Refer to [GI-43. "Intermittent Incident"](#).

>> INSPECTION END

Component Inspection

INFOID:000000007467211

1.CHECK PUSH-BUTTON IGNITION SWITCH

- Turn ignition switch OFF.
- Disconnect push-button ignition switch connector.
- Check continuity between push-button ignition switch terminals.

Push-button ignition switch		Condition	Continuity
Terminal			Existed
1	4	Push-button ignition switch	Existed
			Not existed

Is the inspection result normal?

- YES >> INSPECTION END
 NO >> Replace push-button ignition switch. Refer to [SEC-163. "Removal and Installation"](#).

A
B
C
D
E
F
G
H
I
J
L
M
N
O
P

SEC

B2557 VEHICLE SPEED

< DTC/CIRCUIT DIAGNOSIS >

B2557 VEHICLE SPEED

Description

INFOID:000000007467212

BCM receives 2 vehicle speed signals via CAN communication. 1 signal is transmitted by the “unified meter and A/C amp.”. Another signal is transmitted by “ABS actuator and electric unit (control unit)”. BCM compares both signals to detect the vehicle speed.

DTC Logic

INFOID:000000007467213

DTC DETECTION LOGIC

NOTE:

- If DTC B2557 is displayed with DTC U1000, first perform the trouble diagnosis for DTC U1000. Refer to [SEC-32, "BCM : DTC Logic"](#).
- If DTC B2557 is displayed with DTC U1010, first perform the trouble diagnosis for DTC U1010. Refer to [SEC-34, "BCM : DTC Logic"](#).

DTC No.	Self-diagnosis name	DTC detecting condition	Possible causes
B2557	VEHICLE SPEED	BCM detects the following difference between the vehicle speed signal from “unified meter and A/C amp.” and the one from “ABS actuator and electric unit” for 10 seconds continuously. <ul style="list-style-type: none">• One is 10 km/h (6.2 MPH) or more and the other is 4 km/h (2.5 MPH) or less	<ul style="list-style-type: none">• Wheel sensor• Unified meter and A/C amp.• ABS actuator and electric unit (control unit)

DTC CONFIRMATION PROCEDURE

1. PERFORM DTC CONFIRMATION PROCEDURE

1. Drive the vehicle at the vehicle speed of 10 km/h (6.2 MPH) or more and wait 10 seconds or more.
2. Check “Self-diagnostic result” using CONSULT.

Is DTC detected?

- YES >> Go to [SEC-56, "Diagnosis Procedure"](#).
NO >> INSPECTION END

Diagnosis Procedure

INFOID:000000007467214

1. CHECK DTC WITH “ABS ACTUATOR AND ELECTRIC UNIT (CONTROL UNIT)”

Check “Self-diagnostic result” using CONSULT. Refer to [BRC-99, "DTC Index"](#).

Is the inspection result normal?

- YES >> GO TO 2.
NO >> Repair or replace the malfunctioning parts.

2. CHECK DTC WITH “COMBINATION METER”

Check “Self-diagnostic result” using CONSULT. Refer to [MWI-74, "DTC Index"](#).

Is the inspection result normal?

- YES >> GO TO 3.
NO >> Repair or replace the malfunctioning parts.

3. CHECK INTERMITTENT INCIDENT

Refer to [GI-43, "Intermittent Incident"](#).

>> INSPECTION END

B2560 STARTER CONTROL RELAY

< DTC/CIRCUIT DIAGNOSIS >

B2560 STARTER CONTROL RELAY

Description

INFOID:000000007467215

Starter control relay, integrated in IPDM E/R, permits the starter relay operation when in the N or P position. It is installed parallel to the starter relay.

DTC Logic

INFOID:000000007467216

DTC DETECTION LOGIC

NOTE:

- If DTC B2560 is displayed with DTC U1000, first perform the trouble diagnosis for DTC U1000. Refer to [SEC-32, "BCM : DTC Logic"](#).
- If DTC B2560 is displayed with DTC U1010, first perform the trouble diagnosis for DTC U1010. Refer to [SEC-34, "BCM : DTC Logic"](#).

DTC No.	Self-diagnosis name	DTC detecting condition	Possible causes
B2560	STARTER CONTROL RELAY	BCM detects a discrepancy between the OFF request of starter control relay to IPDM E/R and the feedback. (The feedback is ON instead of OFF.)	IPDM E/R

DTC CONFIRMATION PROCEDURE

1. PERFORM DTC CONFIRMATION PROCEDURE

1. Turn ignition switch ON under the following conditions and wait 2 seconds or more.

A/T models

- Selector lever is in the P or N position
- Do not depress brake pedal

M/T models

- Do not depress clutch pedal
2. Check "Self-diagnostic result" using CONSULT.

Is DTC detected?

- YES >> Go to [SEC-57, "Diagnosis Procedure"](#).
- NO >> INSPECTION END

Diagnosis Procedure

INFOID:000000007467217

1. CHECK DTC WITH IPDM E/R

Check "Self-diagnostic result" using CONSULT. Refer to [SEC-153, "DTC Index"](#).

Is the inspection result normal?

- YES >> GO TO 2.
- NO >> Replace IPDM E/R. Refer to [PCS-31, "Removal and Installation"](#).

2. CHECK INTERMITTENT INCIDENT

Refer to [GI-43, "Intermittent Incident"](#).

>> INSPECTION END

A
B
C
D
E
F
G
H
I
J
L
M
N
O
P

SEC

B2601 SHIFT POSITION

< DTC/CIRCUIT DIAGNOSIS >

B2601 SHIFT POSITION

Description

INFOID:000000007467218

BCM confirms the shift position with the following 4 signals.

- Selector lever
- Transmission range switch
- P position signal from IPDM E/R (CAN)
- P position signal from TCM (CAN)

DTC Logic

INFOID:000000007467219

DTC DETECTION LOGIC

NOTE:

- If DTC B2601 is displayed with DTC U1000, first perform the trouble diagnosis for DTC U1000. Refer to [SEC-32, "BCM : DTC Logic"](#).
- If DTC B2601 is displayed with DTC U1010, first perform the trouble diagnosis for DTC U1010. Refer to [SEC-34, "BCM : DTC Logic"](#).

DTC No.	Trouble diagnosis name	DTC detecting condition	Possible cause
B2601	SHIFT POSITION	BCM detects when a difference between the shift P input signal and the shift position signal received from IPDM E/R via CAN communication continues for 2 seconds or more.	<ul style="list-style-type: none">• Harness or connectors (A/T shift selector circuit is open or shorted)• A/T shift selector (detention switch)

DTC CONFIRMATION PROCEDURE

1. PERFORM DTC CONFIRMATION PROCEDURE

1. Turn ignition switch ON under the following conditions and wait 2 seconds or more.
 - Selector lever is in the P or N position
 - Do not depress brake pedal
2. Check "Self-diagnostic result" using CONSULT.

Is DTC detected?

- YES >> Go to [SEC-58, "Diagnosis Procedure"](#).
NO >> INSPECTION END

Diagnosis Procedure

INFOID:000000007467220

1. CHECK A/T SHIFT SELECTOR POWER SUPPLY

1. Turn ignition switch OFF.
2. Disconnect A/T shift selector (detention switch) connector.
3. Check voltage between A/T shift selector (detention switch) harness connector and ground.

(+)		(-)	Voltage (V) (Approx.)
Connector	Terminal		
M137	10	Ground	Battery voltage

Is the inspection result normal?

- YES >> GO TO 3.
NO >> GO TO 2.

2. CHECK A/T SHIFT SELECTOR POWER SUPPLY CIRCUIT

1. Disconnect BCM connector.
2. Check continuity between A/T shift selector (detention switch) harness connector and BCM harness connector.

B2601 SHIFT POSITION

< DTC/CIRCUIT DIAGNOSIS >

A/T shift selector (detention switch)		BCM		Continuity
Connector	Terminal	Connector	Terminal	
M137	10	M122	96	Existed

3. Check continuity between A/T shift selector (detention switch) harness connector and ground.

A/T shift selector (detention switch)		Ground	Continuity
Connector	Terminal		
M137	10		Not existed

Is the inspection result normal?

YES >> Replace BCM. Refer to [BCS-80, "Removal and Installation"](#).

NO >> Repair or replace harness.

3.CHECK A/T SHIFT SELECTOR CIRCUIT (BCM)

1. Disconnect BCM connector and IPDM E/R connector.
2. Check continuity between A/T shift selector (detention switch) harness connector and BCM harness connector.

A/T shift selector (detention switch)		BCM		Continuity
Connector	Terminal	Connector	Terminal	
M137	11	M122	99	Existed

3. Check continuity between A/T shift selector (detention switch) harness connector and ground.

A/T shift selector (detention switch)		Ground	Continuity
Connector	Terminal		
M137	11		Not existed

Is the inspection result normal?

YES >> GO TO 4.

NO >> Repair or replace harness.

4.CHECK A/T SHIFT SELECTOR CIRCUIT (IPDM E/R)

Check continuity between A/T shift selector (detention switch) harness connector and IPDM E/R harness connector.

A/T shift selector (detention switch)		IPDM E/R		Continuity
Connector	Terminal	Connector	Terminal	
M137	11	E6	43	Existed

Is the inspection result normal?

YES >> GO TO 5.

NO >> Repair or replace harness.

5.CHECK A/T SHIFT SELECTOR (DETENTION SWITCH)

Refer to [SEC-60, "Component Inspection"](#).

Is the inspection result normal?

YES >> GO TO 6.

NO >> Replace A/T shift selector (detention switch). Refer to [TM-266, "2WD : Removal and Installation"](#) (2WD) or [TM-268, "AWD : Removal and Installation"](#) (AWD).

6.CHECK INTERMITTENT INCIDENT

Refer to [GI-43, "Intermittent Incident"](#).

>> INSPECTION END

SEC

B2601 SHIFT POSITION

< DTC/CIRCUIT DIAGNOSIS >

Component Inspection

INFOID:000000007467221

1. CHECK A/T SHIFT SELECTOR (DETENTION SWITCH)

1. Turn ignition switch OFF.
2. Disconnect A/T shift selector (detention switch) connector.
3. Check continuity between A/T shift selector (detention switch) terminals.

A/T shift selector (detention switch)		Condition	Continuity
Terminal			
10	11	Selector lever	P position Not existed
			Other than above Existed

Is the inspection result normal?

YES >> INSPECTION END

NO >> Replace A/T shift selector (detention switch). Refer to [TM-266, "2WD : Removal and Installation"](#) (2WD) or [TM-268, "AWD : Removal and Installation"](#) (AWD).

B2602 SHIFT POSITION

< DTC/CIRCUIT DIAGNOSIS >

B2602 SHIFT POSITION

Description

INFOID:000000007467222

BCM confirms the shift position with the following 4 signals.

- Selector lever
- Transmission range switch
- P position signal from IPDM E/R (CAN)
- P position signal from TCM (CAN)

DTC Logic

INFOID:000000007467223

DTC DETECTION LOGIC

NOTE:

- If DTC B2602 is displayed with DTC U1000, first perform the trouble diagnosis for DTC U1000. Refer to [SEC-32, "BCM : DTC Logic"](#).
- If DTC B2602 is displayed with DTC U1010, first perform the trouble diagnosis for DTC U1010. Refer to [SEC-34, "BCM : DTC Logic"](#).

DTC No.	Trouble diagnosis name	DTC detecting condition	Possible cause
B2602	SHIFT POSITION	BCM detects the following status for 10 seconds. <ul style="list-style-type: none"> • Shift position is in the P position • Vehicle speed is 4 km/h (2.5 MPH) or more • Ignition switch is in the ON position 	<ul style="list-style-type: none"> • Harness or connectors (A/T shift selector circuit is open or shorted) • A/T shift selector (detention switch) • ABS actuator and electric unit (control unit)

DTC CONFIRMATION PROCEDURE

1. PERFORM DTC CONFIRMATION PROCEDURE

1. Start engine.
2. Drive vehicle at a speed of 4 km/h (2.5 MPH) or more for at least 10 seconds.
3. Check "Self-diagnostic result" using CONSULT.

Is DTC detected?

- YES >> Go to [SEC-61, "Diagnosis Procedure"](#).
 NO >> INSPECTION END

Diagnosis Procedure

INFOID:000000007467224

1. CHECK DTC WITH "ABS ACTUATOR AND ELECTRIC UNIT"

Check "Self diagnostic result" using CONSULT. Refer to [BRC-99, "DTC Index"](#).

Is the inspection result normal?

- YES >> GO TO 2.
 NO >> Repair or replace the malfunctioning parts.

2. CHECK A/T SHIFT SELECTOR POWER SUPPLY

1. Turn ignition switch OFF.
2. Disconnect A/T shift selector (detention switch) connector.
3. Check voltage between A/T shift selector (detention switch) harness connector and ground.

(+)		(-)	Voltage (V) (Approx.)
A/T shift selector (detention switch) Connector	Terminal		
M137	10	Ground	Battery voltage

Is the inspection result normal?

- YES >> GO TO 4.

B2602 SHIFT POSITION

< DTC/CIRCUIT DIAGNOSIS >

NO >> GO TO 3.

3.CHECK A/T SHIFT SELECTOR POWER SUPPLY CIRCUIT

1. Disconnect BCM connector.
2. Check continuity between A/T shift selector (detention switch) harness connector and BCM harness connector.

A/T shift selector (detention switch)		BCM		Continuity
Connector	Terminal	Connector	Terminal	
M137	10	M122	96	Existed

3. Check continuity between A/T shift selector (detention switch) harness connector and ground.

A/T shift selector (detention switch)		Ground	Continuity
Connector	Terminal		
M137	10		Not existed

Is the inspection result normal?

YES >> Replace BCM. Refer to [BCS-80, "Removal and Installation"](#).

NO >> Repair or replace harness.

4.CHECK A/T SHIFT SELECTOR CIRCUIT

1. Disconnect BCM connector and IPDM E/R connector.
2. Check continuity between A/T shift selector (detention switch) harness connector and BCM harness connector.

A/T shift selector (detention switch)		BCM		Continuity
Connector	Terminal	Connector	Terminal	
M137	11	M122	99	Existed

3. Check continuity between A/T shift selector (detention switch) harness connector and ground.

A/T shift selector (detention switch)		Ground	Continuity
Connector	Terminal		
M137	11		Not existed

Is the inspection result normal?

YES >> GO TO 5.

NO >> Repair or replace harness.

5.CHECK A/T SHIFT SELECTOR (DETENTION SWITCH)

Refer to [SEC-62, "Component Inspection"](#).

Is the inspection result normal?

YES >> GO TO 6.

NO >> Replace A/T shift selector (detention switch). Refer to [TM-266, "2WD : Removal and Installation"](#) (2WD) or [TM-268, "AWD : Removal and Installation"](#) (AWD).

6.CHECK INTERMITTENT INCIDENT

Refer to [GI-43, "Intermittent Incident"](#).

>> INSPECTION END

Component Inspection

INFOID:000000007771999

1.CHECK A/T SHIFT SELECTOR (DETENTION SWITCH)

1. Turn ignition switch OFF.
2. Disconnect A/T shift selector (detention switch) connector.
3. Check continuity between A/T shift selector (detention switch) terminals.

B2602 SHIFT POSITION

< DTC/CIRCUIT DIAGNOSIS >

A/T shift selector (detention switch)		Condition		Continuity
Terminal				
10	11	Selector lever	P position	Not existed
			Other than above	Existed

Is the inspection result normal?

YES >> INSPECTION END

NO >> Replace A/T shift selector (detention switch). Refer to [TM-266, "2WD : Removal and Installation"](#) (2WD) or [TM-268, "AWD : Removal and Installation"](#) (AWD).

A
B
C
D
E
F
G
H
I
J
L
M
N
O
P

SEC

B2603 SHIFT POSITION

< DTC/CIRCUIT DIAGNOSIS >

B2603 SHIFT POSITION

Description

INFOID:000000007467225

BCM confirms the shift position with the following 4 signals.

- Selector lever
- Transmission range switch
- P position signal from IPDM E/R (CAN)
- P position signal from TCM (CAN)

DTC Logic

INFOID:000000007467226

DTC DETECTION LOGIC

NOTE:

- If DTC B2603 is displayed with DTC U1000, first perform the trouble diagnosis for DTC U1000. Refer to [SEC-32, "BCM : DTC Logic"](#).
- If DTC B2603 is displayed with DTC U1010, first perform the trouble diagnosis for DTC U1010. Refer to [SEC-34, "BCM : DTC Logic"](#).
- If DTC B2603 is displayed with DTC B2601, first perform the trouble diagnosis for DTC B2601. Refer to [SEC-58, "DTC Logic"](#).

DTC No.	Self-diagnosis name	DTC detecting condition	Possible causes
B2603	SHIFT POSITION STATUS	BCM detects the following status for 500 ms or more when shift is in the P position, and ignition switch is in the ON position. <ul style="list-style-type: none">• Transmission range switch: approx. 0 V• A/T shift selector (detention switch): approx. 0 V	<ul style="list-style-type: none">• Harness or connector (A/T shift selector circuit is open or shorted)• Harness or connectors (TCM circuit is open or shorted)• A/T shift selector (detention switch)• TCM

DTC CONFIRMATION PROCEDURE

1. PERFORM DTC CONFIRMATION PROCEDURE

1. Start engine and wait 1 second or more.
2. Check "Self-diagnostic result" using CONSULT.

Is DTC detected?

- YES >> Go to [SEC-64, "Diagnosis Procedure"](#).
NO >> INSPECTION END

Diagnosis Procedure

INFOID:000000007467227

1. CHECK DTC WITH TCM

Check "Self diagnostic result" with CONSULT.

Are any DTC detected?

- YES >> Refer to [TM-242, "DTC Index"](#).
NO >> GO TO 2.

2. CHECK TRANSMISSION RANGE SWITCH CIRCUIT 1

1. Turn ignition switch OFF.
2. Disconnect A/T assembly connector and BCM connector.
3. Check continuity between A/T assembly harness connector and BCM harness connector.

A/T assembly		BCM		Continuity
Connector	Terminal	Connector	Terminal	
F51	9	M123	140	Existed

4. Check continuity between A/T assembly harness connector and ground.

B2603 SHIFT POSITION

< DTC/CIRCUIT DIAGNOSIS >

A/T assembly		Ground	Continuity
Connector	Terminal		
F51	9		Not existed

Is the inspection result normal?

YES >> GO TO 3.

NO >> Repair or replace harness.

3. CHECK TRANSMISSION RANGE SWITCH CIRCUIT 2

1. Disconnect TCM connector.
2. Check continuity between TCM harness connector and A/T assembly harness connector.

TCM		A/T assembly		Continuity
Connector	Terminal	Connector	Terminal	
F157	9	F51	9	Existed

3. Check continuity between TCM harness connector and ground.

TCM		Ground	Continuity
Connector	Terminal		
F157	9		Not existed

Is the inspection result normal?

YES >> GO TO 4.

NO >> Repair or replace harness.

4. CHECK A/T SHIFT SELECTOR POWER SUPPLY

1. Disconnect A/T shift selector (detention switch) connector.
2. Check voltage between A/T shift selector (detention switch) harness connector and ground.

(+)		(-)	Voltage (V) (Approx.)
A/T shift selector (detention switch)			
Connector	Terminal		
M137	10	Ground	Battery voltage

Is the inspection result normal?

YES >> GO TO 6.

NO >> GO TO 5.

5. CHECK A/T SHIFT SELECTOR POWER SUPPLY CIRCUIT

1. Disconnect BCM connector.
2. Check continuity between A/T shift selector (detention switch) harness connector and BCM harness connector.

A/T shift selector (detention switch)		BCM		Continuity
Connector	Terminal	Connector	Terminal	
M137	10	M122	96	Existed

3. Check continuity between A/T shift selector (detention switch) harness connector and ground.

A/T shift selector (detention switch)		Ground	Continuity
Connector	Terminal		
M137	10		Not existed

Is the inspection result normal?

YES >> Replace BCM. Refer to [BCS-80, "Removal and Installation"](#).

NO >> Repair or replace harness.

B2603 SHIFT POSITION

< DTC/CIRCUIT DIAGNOSIS >

6. CHECK A/T SHIFT SELECTOR CIRCUIT

1. Disconnect BCM connector and IPDM E/R connector.
2. Check continuity between A/T shift selector (detention switch) harness connector and BCM harness connector.

A/T shift selector (detention switch)		BCM		Continuity
Connector	Terminal	Connector	Terminal	
M137	11	M122	99	Existed

3. Check continuity between A/T shift selector (detention switch) harness connector and ground.

A/T shift selector (detention switch)		Ground	Continuity
Connector	Terminal		
M137	11		Not existed

Is the inspection result normal?

- YES >> GO TO 7.
NO >> Repair or replace harness.

7. CHECK A/T SHIFT SELECTOR (DETENTION SWITCH)

Refer to [SEC-66. "Component Inspection"](#).

Is the inspection result normal?

- YES >> GO TO 8.
NO >> Replace A/T shift selector (detention switch). Refer to [TM-266. "2WD : Removal and Installation"](#) (2WD) or [TM-268. "AWD : Removal and Installation"](#) (AWD).

8. CHECK INTERMITTENT INCIDENT

Refer to [GI-43. "Intermittent Incident"](#).

>> INSPECTION END

Component Inspection

INFOID:000000007772000

1. CHECK A/T SHIFT SELECTOR (DETENTION SWITCH)

1. Turn ignition switch OFF.
2. Disconnect A/T shift selector (detention switch) connector.
3. Check continuity between A/T shift selector (detention switch) terminals.

A/T shift selector (detention switch)		Condition	Continuity	
Terminal				
10	11	Selector lever	P position	Not existed
			Other than above	Existed

Is the inspection result normal?

- YES >> INSPECTION END
NO >> Replace A/T shift selector (detention switch). Refer to [TM-266. "2WD : Removal and Installation"](#) (2WD) or [TM-268. "AWD : Removal and Installation"](#) (AWD).

B2604 SHIFT POSITION

< DTC/CIRCUIT DIAGNOSIS >

B2604 SHIFT POSITION

Description

INFOID:000000007467228

BCM confirms the shift position with the following 4 signals.

- Selector lever
- Transmission range switch
- P position signal from IPDM E/R (CAN)
- P position signal from TCM (CAN)

DTC Logic

INFOID:000000007467229

DTC DETECTION LOGIC

NOTE:

- If DTC B2604 is displayed with DTC U1000, first perform the trouble diagnosis for DTC U1000. Refer to [SEC-32, "BCM : DTC Logic"](#).
- If DTC B2604 is displayed with DTC U1010, first perform the trouble diagnosis for DTC U1010. Refer to [SEC-34, "BCM : DTC Logic"](#).

DTC No.	Trouble diagnosis name	DTC detecting condition	Possible cause
B2604	PNP SWITCH	BCM detects the following status for 500 ms or more when the ignition switch is in the ON position. <ul style="list-style-type: none"> • N position input signal exists. Shift position signal from TCM does not exist. • N position input signal does not exist. Shift position signal from TCM exists. 	<ul style="list-style-type: none"> • Harness or connectors (TCM circuit is open or shorted) • TCM

DTC CONFIRMATION PROCEDURE

1. PERFORM DTC CONFIRMATION PROCEDURE

1. Start engine and wait 1 second or more.
2. Check "Self-diagnostic result" using CONSULT.

Is DTC detected?

- YES >> Go to [SEC-67, "Diagnosis Procedure"](#).
 NO >> INSPECTION END

Diagnosis Procedure

INFOID:000000007467230

1. CHECK DTC WITH TCM

Check "Self diagnostic result" using CONSULT.

Are any DTC detected?

- YES >> Refer to [TM-242, "DTC Index"](#).
 NO >> GO TO 2.

2. CHECK TRANSMISSION RANGE SWITCH CIRCUIT 1

1. Turn ignition switch OFF.
2. Disconnect A/T assembly connector and BCM connector.
3. Check continuity between A/T assembly harness connector and BCM harness connector.

A/T assembly		BCM		Continuity
Connector	Terminal	Connector	Terminal	
F51	9	M123	140	Existed

4. Check continuity between A/T assembly harness connector and ground.

B2604 SHIFT POSITION

< DTC/CIRCUIT DIAGNOSIS >

A/T assembly		Ground	Continuity
Connector	Terminal		
F51	9		Not existed

Is the inspection result normal?

YES >> GO TO 3.

NO >> Repair or replace harness.

3. CHECK TRANSMISSION RANGE SWITCH CIRCUIT 2

1. Disconnect TCM connector.
2. Check continuity between TCM harness connector and A/T assembly harness connector.

TCM		A/T assembly		Continuity
Connector	Terminal	Connector	Terminal	
F157	9	F51	9	Existed

3. Check continuity between TCM harness connector and ground.

TCM		Ground	Continuity
Connector	Terminal		
F157	9		Not existed

Is the inspection result normal?

YES >> GO TO 4.

NO >> Repair or replace harness.

4. CHECK INTERMITTENT INCIDENT

Refer to [GI-43. "Intermittent Incident"](#).

>> INSPECTION END

B2605 SHIFT POSITION

< DTC/CIRCUIT DIAGNOSIS >

B2605 SHIFT POSITION

Description

INFOID:000000007467231

BCM confirms the shift position with the following 4 signals.

- Selector lever
- Transmission range switch
- P position signal from IPDM E/R (CAN)
- P position signal from TCM (CAN)

DTC Logic

INFOID:000000007467232

DTC DETECTION LOGIC

NOTE:

- If DTC B2605 is displayed with DTC U1000, first perform the trouble diagnosis for DTC U1000. Refer to [SEC-32. "BCM : DTC Logic"](#).
- If DTC B2605 is displayed with DTC U1010, first perform the trouble diagnosis for DTC U1010. Refer to [SEC-34. "BCM : DTC Logic"](#).

DTC No.	Trouble diagnosis name	DTC detecting condition	Possible cause
B2605	PNP SWITCH	BCM detects the following status for 500 ms or more when the ignition switch is in the ON position <ul style="list-style-type: none"> • N position input signal exists. Shift position signal from IPDM E/R does not exist. • N position input signal does not exist. Shift position signal from IPDM E/R exists. 	<ul style="list-style-type: none"> • Harness or connectors (TCM circuit is open or shorted) • TCM • IPDM E/R

DTC CONFIRMATION PROCEDURE

1. PERFORM DTC CONFIRMATION PROCEDURE

1. Turn ignition switch ON under the following conditions and wait 1 second or more.
 - Selector lever is in the P or N position
 - Do not depress brake pedal
2. Check "Self-diagnostic result" using CONSULT.

Is DTC detected?

YES >> Go to [SEC-69. "Diagnosis Procedure"](#).

NO >> INSPECTION END

Diagnosis Procedure

INFOID:000000007467233

1. CHECK DTC WITH IPDM E/R

Check "Self diagnostic result" using CONSULT. Refer to [SEC-153. "DTC Index"](#).

Is the inspection result normal?

YES >> GO TO 2.

NO >> Repair or replace the malfunctioning parts.

2. CHECK TRANSMISSION RANGE SWITCH CIRCUIT 1

1. Turn ignition switch OFF.
2. Disconnect A/T assembly connector and BCM connector.
3. Check continuity between A/T assembly harness connector and BCM harness connector.

A/T assembly		BCM		Continuity
Connector	Terminal	Connector	Terminal	
F51	9	M123	140	Existed

4. Check continuity between A/T assembly harness connector and ground.

B2605 SHIFT POSITION

< DTC/CIRCUIT DIAGNOSIS >

A/T assembly		Ground	Continuity
Connector	Terminal		
F51	9		Not existed

Is the inspection result normal?

YES >> GO TO 3.

NO >> Repair or replace harness.

3. CHECK TRANSMISSION RANGE SWITCH CIRCUIT 2

1. Disconnect TCM connector.
2. Check continuity between TCM harness connector and A/T assembly harness connector.

TCM		A/T assembly		Continuity
Connector	Terminal	Connector	Terminal	
F157	9	F51	9	Existed

3. Check continuity between TCM harness connector and ground.

TCM		Ground	Continuity
Connector	Terminal		
F157	9		Not existed

Is the inspection result normal?

YES >> GO TO 4.

NO >> Repair or replace harness.

4. CHECK INTERMITTENT INCIDENT

Refer to [GI-43. "Intermittent Incident"](#).

>> INSPECTION END

B2608 STARTER RELAY

< DTC/CIRCUIT DIAGNOSIS >

B2608 STARTER RELAY

Description

INFOID:000000007467240

Located in IPDM E/R, the starter relay runs the starter motor. The starter relay is turned ON by the BCM when the ignition switch is in the START position. IPDM E/R transmits the starter relay ON signal to BCM via CAN communication.

DTC Logic

INFOID:000000007467241

DTC DETECTION LOGIC

NOTE:

- If DTC B2608 is displayed with DTC U1000, first perform the trouble diagnosis for DTC U1000. Refer to [SEC-32, "BCM : DTC Logic"](#).
- If DTC B2608 is displayed with DTC U1010, first perform the trouble diagnosis for DTC U1010. Refer to [SEC-34, "BCM : DTC Logic"](#).
- If DTC B2608 is displayed with DTC B210D for IPDM E/R, first perform the trouble diagnosis for DTC B210D. Refer to [SEC-85, "DTC Logic"](#).

DTC No.	Trouble diagnosis name	DTC detecting condition	Possible cause
B2608	STARTER RELAY	BCM receives starter relay ON signal (CAN) from IPDM E/R even if BCM turns the starter relay OFF.	<ul style="list-style-type: none"> • Harness or connectors (Starter relay circuit is open or shorted.) • IPDM E/R

DTC CONFIRMATION PROCEDURE

1. PERFORM DTC CONFIRMATION PROCEDURE

1. Turn ignition switch ON under the following conditions.

A/T models

- Selector lever is in the P or N position
- Do not depress brake pedal

M/T models

- Do not depress clutch pedal
2. Check "Self-diagnostic result" using CONSULT.

Is DTC detected?

- YES >> Go to [SEC-71, "Diagnosis Procedure"](#).
 NO >> INSPECTION END

Diagnosis Procedure

INFOID:000000007467242

1. CHECK BCM POWER SUPPLY CIRCUIT

1. Turn ignition switch ON.
2. Check voltage between BCM harness connector and ground.

(+)		(-)	Condition	Voltage (V) (Approx.)	
BCM					
Connector	Terminal				
M121	52	Ground	Selector lever (A/T models)	N or P position	12
				Other than above	0
			Clutch pedal (M/T models)	Depressed	Battery voltage
				Not depressed	0

Is the measurement value within the specification?

- YES >> GO TO 3.
 NO >> GO TO 2.

B2608 STARTER RELAY

< DTC/CIRCUIT DIAGNOSIS >

2. CHECK STARTER RELAY CIRCUIT

1. Turn ignition switch OFF.
2. Disconnect BCM connector and IPDM E/R connector.
3. Check continuity between IPDM E/R harness connector and BCM harness connector.

IPDM E/R		BCM		Continuity
Connector	Terminal	Connector	Terminal	
E6	46	M121	52	Existed

4. Check continuity between IPDM E/R harness connector and ground.

IPDM E/R		Ground	Continuity
Connector	Terminal		
E6	46		Not existed

Is the inspection result normal?

- YES >> Replace IPDM E/R. Refer to [PCS-31, "Removal and Installation"](#).
NO >> Repair or replace harness.

3. CHECK INTERMITTENT INCIDENT

Refer to [GI-43, "Intermittent Incident"](#).

>> INSPECTION END

B260F ENGINE STATUS

< DTC/CIRCUIT DIAGNOSIS >

B260F ENGINE STATUS

Description

INFOID:000000007467255

BCM receives the engine status signal from ECM via CAN communication.

DTC Logic

INFOID:000000007467256

DTC DETECTION LOGIC

NOTE:

- If DTC B260F is displayed with DTC U1000, first perform the trouble diagnosis for DTC U1000. Refer to [SEC-32, "BCM : DTC Logic"](#).
- If DTC B260F is displayed with DTC U1010, first perform the trouble diagnosis for DTC U1010. Refer to [SEC-34, "BCM : DTC Logic"](#).

DTC No.	Trouble diagnosis name	DTC detecting condition	Possible cause
B260F	INTERRUPTION OF ENGINE STATUS SIGNAL	BCM has not yet received the engine status signal from ECM when ignition switch is in the ON position.	ECM

DTC CONFIRMATION PROCEDURE

1. PERFORM DTC CONFIRMATION PROCEDURE

1. Turn ignition switch ON under the following conditions.

A/T models

- Selector lever is in the P or N position
- Do not depress brake pedal

M/T models

- Do not depress clutch pedal
2. Check "Self-diagnostic result" using CONSULT.

Is DTC detected?

- YES >> Go to [SEC-73, "Diagnosis Procedure"](#).
- NO >> INSPECTION END

Diagnosis Procedure

INFOID:000000007467257

SEC

1. INSPECTION START

1. Turn ignition switch ON.
2. Check "Self-diagnostic result" using CONSULT.
3. Touch "ERASE".
4. **Perform DTC Confirmation Procedure.**
See [SEC-73, "DTC Logic"](#).

Is the DTC B260F displayed again?

- YES >> GO TO 2.
- NO >> GO TO 3.

2. REPLACE ECM

Replace ECM. Refer to the following.

- VQ37 engine models: [EC-32, "ADDITIONAL SERVICE WHEN REPLACING CONTROL UNIT \(ECM\) : Description"](#)
- VQ25 engine models (except for Mexico): [EC-634, "ADDITIONAL SERVICE WHEN REPLACING CONTROL UNIT \(ECM\) : Description"](#)
- VQ25 engine models (for Mexico): [EC-1177, "ADDITIONAL SERVICE WHEN REPLACING CONTROL UNIT \(ECM\) : Description"](#)

>> INSPECTION END

3. CHECK INTERMITTENT INCIDENT

B260F ENGINE STATUS

< DTC/CIRCUIT DIAGNOSIS >

Refer to [GI-43, "Intermittent Incident"](#).

>> INSPECTION END

B26E8 CLUTCH INTERLOCK SWITCH

< DTC/CIRCUIT DIAGNOSIS >

B26E8 CLUTCH INTERLOCK SWITCH

Description

INFOID:000000007467258

When clutch interlock switch turns ON, BCM detects that clutch pedal is being depressed and permits to start the engine.

DTC Logic

INFOID:000000007467259

NOTE:

If DTC B26E8 is displayed with DTC B210F, first perform the trouble diagnosis for DTC B210F. Refer to [SEC-88. "DTC Logic"](#).

DTC DETECTION LOGIC

DTC No.	Trouble diagnosis name	DTC detection condition	Possible cause
B26E8	CLUTCH INTERLOCK SWITCH	Detects that ASCD cancel switch is in the ON position for 2 seconds or more while ignition switch and clutch interlock switch are ON.	<ul style="list-style-type: none"> Clutch interlock switch Harness or connector (Clutch interlock switch circuit open or shorted)

DTC CONFIRMATION PROCEDURE

1. PERFORM DTC CONFIRMATION PROCEDURE

- Turn ignition switch ON under the following condition.
 - Shift lever is in the neutral position.
 - Depress clutch pedal.
- Check "Self-diagnostic result" using CONSULT.

Is DTC detected?

- YES >> Go to [SEC-75. "Diagnosis Procedure"](#).
 NO >> INSPECTION END

Diagnosis Procedure

INFOID:000000007467260

1. CHECK CLUTCH INTERLOCK SWITCH POWER SUPPLY

- Turn ignition switch OFF.
- Disconnect clutch interlock switch connector.
- Check voltage between clutch interlock switch harness connector and ground.

(+)		(-)	Voltage (V) (Approx.)
Clutch interlock switch			
Connector	Terminal		
E111	1	Ground	Battery voltage

Is the inspection result normal?

- YES >> GO TO 2.
 NO-1 >> Check 10 A fuse [No. 9, located in the fuse block (J/B)]
 NO-2 >> Check harness for open or short between clutch interlock switch and fuse.

2. CHECK CLUTCH INTERLOCK SWITCH SIGNAL

- Connect clutch interlock switch connector.
- Disconnect BCM connector.
- Check voltage between BCM harness connector and ground.

B26E8 CLUTCH INTERLOCK SWITCH

< DTC/CIRCUIT DIAGNOSIS >

(+)		(-)	Condition	Voltage (V) (Approx.)	
BCM					
Connector	Terminal				
M123	114	Ground	Clutch pedal	Depressed	Battery voltage
				Not depressed	0

Is the inspection result normal?

YES >> Replace BCM. Refer to [BCS-80, "Removal and Installation"](#).

NO >> GO TO 3.

3. CHECK CLUTCH INTERLOCK SWITCH SIGNAL CIRCUIT

1. Disconnect clutch interlock switch connector.
2. Check continuity between clutch interlock switch harness connector and BCM harness connector.

Clutch interlock switch		BCM		Continuity
Connector	Terminal	Connector	Terminal	
E111	2	M123	114	Existed

3. Check continuity between clutch interlock switch harness connector and ground.

Clutch interlock switch		Ground	Continuity
Connector	Terminal		
E111	2		Not existed

Is the inspection result normal?

YES >> GO TO 4.

NO >> Repair or replace harness.

4. CHECK CLUTCH INTERLOCK SWITCH

Refer to [SEC-76, "Component Inspection"](#).

Is the inspection result normal?

YES >> GO TO 5.

NO >> Replace clutch interlock switch. Refer to [CL-9, "Exploded View"](#).

5. CHECK INTERMITTENT INCIDENT

Refer to [GI-43, "Intermittent Incident"](#).

>> INSPECTION END

Component Inspection

INFOID:000000007467261

1. CHECK CLUTCH INTERLOCK SWITCH

1. Turn ignition switch OFF.
2. Disconnect clutch interlock switch connector.
3. Check continuity between clutch interlock switch terminals.

Clutch interlock switch		Condition	Continuity	
Terminal				
1	2	Clutch pedal	Depressed	Existed
			Not depressed	Not existed

Is the inspection result normal?

YES >> INSPECTION END

NO >> Replace clutch interlock switch. Refer to [CL-9, "Exploded View"](#).

B26EA KEY REGISTRATION

< DTC/CIRCUIT DIAGNOSIS >

B26EA KEY REGISTRATION

Description

INFOID:000000007467265

When the registered Intelligent Key is carried, the door lock/unlock operation and the push-button ignition switch operation become possible.

DTC Logic

INFOID:000000007467266

DTC DETECTION LOGIC

DTC No.	Trouble diagnosis name	DTC detecting condition	Possible cause
B26EA	KEY REGISTRATION	Intelligent Key is not registered successfully.	<ul style="list-style-type: none">Improper registration operationIntelligent KeyBCM

DTC CONFIRMATION PROCEDURE

1. PERFORM DTC CONFIRMATION PROCEDURE

1. Perform initialization using CONSULT. Register all Intelligent Keys.
For initialization and registration of Intelligent Key, follow the instruction of CONSULT display.
2. Check "Self-diagnostic result" using CONSULT.

Is DTC detected?

YES >> Go to [SEC-77. "Diagnosis Procedure"](#)
NO >> INSPECTION END

Diagnosis Procedure

INFOID:000000007467267

1. PERFORM INITIALIZATION

1. Perform initialization using CONSULT. Register all Intelligent Keys.
For initialization and registration of Intelligent Key, follow the instruction of CONSULT display.
2. Check "Self-diagnostic result" using CONSULT.

Is DTC detected?

YES >> GO TO 2.
NO >> INSPECTION END

2. REPLACE INTELLIGENT KEY

1. Replace Intelligent Key. Register all Intelligent Keys
2. Perform initialization using CONSULT. For initialization, follow the instruction of CONSULT display.
3. Check "Self-diagnostic result" using CONSULT.

Is DTC detected?

YES >> Replace BCM. Refer to [BCS-80. "Removal and Installation"](#).
NO >> INSPECTION END

B2617 STARTER RELAY CIRCUIT

< DTC/CIRCUIT DIAGNOSIS >

B2617 STARTER RELAY CIRCUIT

Description

INFOID:000000007467271

Located in IPDM E/R, the starter relay runs the starter motor. The starter relay is turned ON by the BCM when the ignition switch is in the START position. IPDM E/R transmits the starter relay ON signal to BCM via CAN communication.

DTC Logic

INFOID:000000007467272

DTC DETECTION LOGIC

NOTE:

- If DTC B2617 is displayed with DTC U1000, first perform the trouble diagnosis for DTC U1000. Refer to [SEC-32, "BCM : DTC Logic"](#).
- If DTC B2617 is displayed with DTC U1010, first perform the trouble diagnosis for DTC U1010. Refer to [SEC-34, "BCM : DTC Logic"](#).
- If DTC B2617 is displayed with DTC B210E for IPDM E/R, first perform the trouble diagnosis for DTC B210E. Refer to [SEC-86, "DTC Logic"](#).

DTC No.	Trouble diagnosis name	DTC detecting condition	Possible cause
B2617	STARTER RELAY CIRCUIT	An immediate operation of starter relay is requested by BCM, but there is no response for more than 1 second.	<ul style="list-style-type: none">• Harness or connectors (Starter relay circuit is open or shorted.)• IPDM E/R

DTC CONFIRMATION PROCEDURE

1. PERFORM DTC CONFIRMATION PROCEDURE

1. Turn ignition switch ON under the following conditions and wait 1 second or more.

A/T models

- Selector lever is in the P or N position
- Do not depress brake pedal

M/T models

- Do not depress clutch pedal
2. Check "Self-diagnostic result" using CONSULT.

Is DTC detected?

- YES >> Go to [SEC-78, "Diagnosis Procedure"](#).
NO >> INSPECTION END

Diagnosis Procedure

INFOID:000000007467273

1. CHECK STARTER RELAY

1. Turn ignition switch ON.
2. Check voltage between BCM harness connector and ground.

(+)		(-)	Condition		Voltage (V) (Approx.)
BCM					
Connector	Terminal				
M121	52	Ground	Selector lever (A/T models)	N or P position	12
				Other than above	0
			Clutch pedal (M/T models)	Depressed	Battery voltage
				Not depressed	0

Is the measurement value within the specification.

- YES >> GO TO 3.
NO >> GO TO 2.

B2617 STARTER RELAY CIRCUIT

< DTC/CIRCUIT DIAGNOSIS >

2. CHECK STARTER RELAY CIRCUIT

1. Turn ignition switch OFF.
2. Disconnect BCM connector and IPDM E/R connector.
3. Check continuity between IPDM E/R harness connector and BCM harness connector.

IPDM E/R		BCM		Continuity
Connector	Terminal	Connector	Terminal	
E6	46	M121	52	Existed

4. Check continuity between IPDM E/R harness connector and ground.

IPDM E/R		Ground	Continuity
Connector	Terminal		
E6	46		Not existed

Is the inspection result normal?

- YES >> Replace IPDM E/R. Refer to [PCS-31, "Removal and Installation"](#).
NO >> Repair or replace harness.

3. CHECK INTERMITTENT INCIDENT

Refer to [GI-43, "Intermittent Incident"](#).

>> INSPECTION END

A
B
C
D
E
F
G
H
I
J
L
M
N
O
P

SEC

B261E VEHICLE TYPE

< DTC/CIRCUIT DIAGNOSIS >

B261E VEHICLE TYPE

Description

INFOID:000000007467277

There are two types of vehicles.

- HEV
- Conventional

DTC Logic

INFOID:000000007467278

DTC DETECTION LOGIC

NOTE:

- If DTC B261E is displayed with DTC U1000, first perform the trouble diagnosis for DTC U1000. Refer to [SEC-32, "BCM : DTC Logic"](#).
- If DTC B261E is displayed with DTC U1010, first perform the trouble diagnosis for DTC U1010. Refer to [SEC-34, "BCM : DTC Logic"](#).

DTC No.	Trouble diagnosis name	DTC detecting condition	Possible cause
B261E	VEHICLE TYPE	Difference of BCM configuration.	BCM

DTC CONFIRMATION PROCEDURE

1. PERFORM DTC CONFIRMATION PROCEDURE

1. Turn ignition switch ON under the following conditions.

A/T models

- Selector lever is in the P or N position
- Do not depress brake pedal

M/T models

- Do not depress clutch pedal
2. Check "Self-diagnostic result" using CONSULT.

Is DTC detected?

- YES >> Go to [SEC-80, "Diagnosis Procedure"](#).
- NO >> INSPECTION END

Diagnosis Procedure

INFOID:000000007467279

1. INSPECTION START

1. Turn ignition switch ON.
2. Check "Self-diagnostic result" using CONSULT.
3. Touch "ERASE".
4. **Perform DTC Confirmation Procedure.**
See [SEC-80, "DTC Logic"](#).

Is the 1st trip DTC B261E displayed again?

- YES >> Replace BCM. Refer to [BCS-80, "Removal and Installation"](#).
- NO >> INSPECTION END

B261F ASCD CLUTCH SWITCH

< DTC/CIRCUIT DIAGNOSIS >

B261F ASCD CLUTCH SWITCH

Description

INFOID:000000007467280

BCM judges that clutch pedal is operated by clutch interlock switch and ASCD clutch switch operation.

DTC Logic

INFOID:000000007467281

DTC DETECTION LOGIC

DTC No.	Trouble diagnosis name	DTC detection condition	Possible cause
B261F	ASCD CNCL/CLTH SW	When ignition switch is ON and vehicle speed is 40 km/h, BCM detects that ASCD clutch switch is ON for 10 seconds or more.	<ul style="list-style-type: none"> • Harness or connector (ASCD clutch switch circuit open or shorted) • ASCD clutch switch • BCM

DTC CONFIRMATION PROCEDURE

1. PERFORM DTC CONFIRMATION PROCEDURE

1. Drive the vehicle at the vehicle speed of 40 km/h (24.8 MPH) or more wait for least 10 seconds.
2. Check "Self-diagnostic result" using CONSULT.

Is DTC detected?

- YES >> Go to [SEC-81, "Diagnosis Procedure"](#).
 NO >> INSPECTION END

Diagnosis Procedure

INFOID:000000007467282

1. CHECK ASCD CLUTCH SWITCH POWER SUPPLY

1. Turn ignition switch OFF.
2. Disconnect ASCD clutch switch connector.
3. Turn ignition switch ON.
4. Check voltage between ASCD clutch switch harness connector and ground.

(+)		(-)	Voltage (V) (Approx.)
ASCD clutch switch			
Connector	Terminal	Ground	Battery voltage
E108 (Without ICC)	1		
E113 (With ICC)			

Is the inspection result normal?

- YES >> GO TO 2.
 NO-1 >> Check ASCD brake switch. Refer to [BR-18, "Exploded View"](#).
 NO-2 >> Check 10A fuse [No. 3, located in the fuse block (J/B)]
 NO-3 >> Check harness for open or short between ASCD clutch switch and fuse.

2. CHECK ASCD CLUTCH SWITCH SIGNAL

1. Turn ignition switch OFF.
2. Connect ASCD clutch switch connector.
3. Disconnect BCM connector.
4. Check voltage between BCM harness connector and ground.

(+)		(-)	Condition	Voltage (V) (Approx.)	
BCM					
Connector	Terminal	Ground	Clutch pedal	Depressed	
M122	99				Not depressed
				0	

B261F ASCD CLUTCH SWITCH

< DTC/CIRCUIT DIAGNOSIS >

Is the inspection result normal?

- YES >> Replace BCM. Refer to [BCS-80, "Removal and Installation"](#).
 NO >> GO TO 3.

3. CHECK ASCD CLUTCH SWITCH SIGNAL CIRCUIT

1. Disconnect ASCD clutch switch connector.
2. Check continuity between ASCD clutch switch harness connector and BCM harness connector.

ASCD clutch switch		BCM		Continuity
Connector	Terminal	Connector	Terminal	
E108 (Without ICC)	2	M122	99	Existed
E113 (With ICC)				

3. Check continuity between ASCD clutch switch harness connector and ground.

ASCD clutch switch		Ground	Continuity
Connector	Terminal		
E108 (Without ICC)	2		Not existed
E113 (With ICC)			

Is the inspection result normal?

- YES >> GO TO 4.
 NO >> Repair or replace harness.

4. CHECK ASCD CLUTCH SWITCH

Refer to [SEC-82, "Component Inspection"](#).

Is the inspection result normal?

- YES >> GO TO 5.
 NO >> Replace ASCD clutch switch. Refer to [CL-9, "Exploded View"](#).

5. CHECK INTERMITTENT INCIDENT

Refer to [GI-43, "Intermittent Incident"](#).

>> INSPECTION END

Component Inspection

INFOID:000000007467283

1. CHECK ASCD CLUTCH SWITCH

1. Turn ignition switch OFF.
2. Disconnect ASCD clutch switch connector.
3. Check continuity between ASCD clutch switch terminals.

ASCD clutch switch		Condition	Continuity
Terminal			
1	2	Clutch pedal Depressed	Not existed
		Clutch pedal Not depressed	Existed

Is the inspection result normal?

- YES >> INSPECTION END
 NO >> Replace ASCD clutch switch. Refer to [CL-9, "Exploded View"](#).

B210B STARTER CONTROL RELAY

< DTC/CIRCUIT DIAGNOSIS >

B210B STARTER CONTROL RELAY

Description

INFOID:000000007467293

Starter control relay, integrated in IPDM E/R, permits the starter relay operation when in the N or P position. It is installed parallel to the starter relay.

DTC Logic

INFOID:000000007467294

DTC DETECTION LOGIC

NOTE:

If DTC B210B is displayed with DTC U1000, first perform the trouble diagnosis for DTC U1000. Refer to [SEC-32, "IPDM E/R : DTC Logic"](#).

DTC No.	Trouble diagnosis name	DTC detecting condition	Possible cause
B210B	START CONT RLY ON	IPDM E/R detects that the relay is stuck in the ON position even if the following conditions are met for about 1 second. <ul style="list-style-type: none">• Starter control relay ON/OFF signal from BCM• Transmission range switch input signal	IPDM E/R

DTC CONFIRMATION PROCEDURE

1. PERFORM DTC CONFIRMATION PROCEDURE

1. Turn the power supply position to start under the following conditions and wait 1 second or more.

A/T models

- Selector lever is in the P or N position
- Do not depress brake pedal

M/T models

- Do not depress clutch pedal
2. Check "Self-diagnostic result" using CONSULT.

Is DTC detected?

- YES >> Go to [SEC-83, "Diagnosis Procedure"](#).
NO >> INSPECTION END

Diagnosis Procedure

INFOID:000000007467295

1. INSPECTION START

1. Turn ignition switch ON.
2. Check "Self-diagnostic result" for IPDM E/R using CONSULT.
3. Touch "ERASE".
4. **Perform DTC Confirmation Procedure.**
See [SEC-83, "DTC Logic"](#).

Is the DTC B210B displayed again?

- YES >> Replace IPDM E/R. Refer [PCS-31, "Removal and Installation"](#).
NO >> INSPECTION END

B210C STARTER CONTROL RELAY

< DTC/CIRCUIT DIAGNOSIS >

B210C STARTER CONTROL RELAY

Description

INFOID:000000007467296

Starter control relay, integrated in IPDM E/R, permits the starter relay operation when in the N or P position. It is installed parallel to the starter relay.

DTC Logic

INFOID:000000007467297

DTC DETECTION LOGIC

NOTE:

- If DTC B210C is displayed with DTC U1000, first perform the trouble diagnosis for DTC U1000. Refer to [SEC-32, "IPDM E/R : DTC Logic"](#).
- When IPDM E/R power supply voltage is low (Approx. 7 - 8 V for about 1 second), the DTC B210C may be detected.

DTC No.	Trouble diagnosis name	DTC detecting condition	Possible cause
B210C	START CONT RLY OFF	IPDM E/R detects that the relay is stuck in the OFF position even if the following conditions are met for about 1 second. <ul style="list-style-type: none">• Starter control relay ON/OFF signal from BCM• Transmission range switch input signal	<ul style="list-style-type: none">• IPDM E/R• Battery

DTC CONFIRMATION PROCEDURE

1. PERFORM DTC CONFIRMATION PROCEDURE

1. Turn the power supply position to start under the following conditions and wait 1 second or more.

A/T models

- Selector lever is in the P or N position
- Do not depress brake pedal

M/T models

- Do not depress clutch pedal
2. Check "Self-diagnostic result" using CONSULT.

Is DTC detected?

- YES >> Go to [SEC-84, "Diagnosis Procedure"](#).
NO >> INSPECTION END

Diagnosis Procedure

INFOID:000000007467298

1. INSPECTION START

1. Turn ignition switch ON.
2. Check "Self-diagnostic result" for IPDM E/R using CONSULT.
3. Touch "ERASE".
4. **Perform DTC Confirmation Procedure.**
See [SEC-84, "DTC Logic"](#).

Is the DTC B210C displayed again?

- YES >> Replace IPDM E/R. Refer to [PCS-31, "Removal and Installation"](#).
NO >> INSPECTION END

B210D STARTER RELAY

< DTC/CIRCUIT DIAGNOSIS >

B210D STARTER RELAY

Description

INFOID:000000007467299

Located in IPDM E/R, the starter relay runs the starter motor. The starter relay is turned ON by the BCM when the ignition switch is in the START position. IPDM E/R transmits the starter relay ON signal to BCM via CAN communication.

DTC Logic

INFOID:000000007467300

DTC DETECTION LOGIC

NOTE:

- If DTC B210D is displayed with DTC U1000, first perform the trouble diagnosis for DTC U1000. Refer to [SEC-32, "IPDM E/R : DTC Logic"](#).
- If DTC B210D is displayed with DTC B2617, first perform the trouble diagnosis for DTC B2617. Refer to [SEC-78, "DTC Logic"](#).

DTC No.	Trouble diagnosis name	DTC detecting condition	Possible cause
B210D	STARTER RELAY ON	IPDM E/R detects that the relay is stuck in the ON position even if the following conditions are met for about 1 second. <ul style="list-style-type: none">• Starter control relay ON/OFF signal from BCM• Transmission range switch input	IPDM E/R

DTC CONFIRMATION PROCEDURE

1. PERFORM DTC CONFIRMATION PROCEDURE

1. Turn ignition switch ON under the following conditions and wait for 1 second or more.

A/T models

- Selector lever is in the P or N position
- Do not depress brake pedal

M/T models

- Do not depress clutch pedal
2. Check "Self-diagnostic result" using CONSULT.

Is DTC detected?

- YES >> Go to [SEC-85, "Diagnosis Procedure"](#).
NO >> INSPECTION END

Diagnosis Procedure

INFOID:000000007467301

1. INSPECTION START

1. Turn ignition switch ON.
2. Check "Self-diagnostic result" for IPDM E/R using CONSULT.
3. Touch "ERASE".
4. **Perform DTC Confirmation Procedure.**
See [SEC-85, "DTC Logic"](#).

Is the DTC B210D displayed again?

- YES >> Replace IPDM E/R. Refer to [PCS-31, "Removal and Installation"](#).
NO >> INSPECTION END

B210E STARTER RELAY

< DTC/CIRCUIT DIAGNOSIS >

B210E STARTER RELAY

Description

INFOID:000000007467302

Located in IPDM E/R, the starter relay runs the starter motor. The starter relay is turned ON by the BCM when the ignition switch is in the START position. IPDM E/R transmits the starter relay ON signal to BCM via CAN communication.

DTC Logic

INFOID:000000007467303

DTC DETECTION LOGIC

NOTE:

- If DTC B210E is displayed with DTC U1000, first perform the trouble diagnosis for DTC U1000. Refer to [SEC-32, "IPDM E/R : DTC Logic"](#).
- If DTC B210E is displayed with DTC B2110 for IPDM E/R, first perform the trouble diagnosis for DTC B2110. Refer to [SEC-90, "DTC Logic"](#).
- When IPDM E/R power supply voltage is low (Approx. 7 - 8 V for about 1 second), the DTC B210F may be detected.

DTC No.	Trouble diagnosis name	DTC detecting condition	Possible cause
B210E	STARTER RELAY OFF	IPDM E/R detects that the relay is stuck in the OFF position even if the following conditions are met for about 1 second. <ul style="list-style-type: none"> • Starter control relay ON/OFF signal from BCM • Transmission range switch input 	<ul style="list-style-type: none"> • Harness or connector (Starter relay circuit is open or short) • IPDM E/R • Battery • BCM

DTC CONFIRMATION PROCEDURE

1. PERFORM DTC CONFIRMATION PROCEDURE

1. Turn ignition switch ON under the following conditions and wait 1 second or more.

A/T models

- Selector lever is in the P or N position
- Do not depress brake pedal

M/T models

- Do not depress clutch pedal
2. Check "Self-diagnostic result" using CONSULT.

Is DTC detected?

- YES >> Go to [SEC-86, "Diagnosis Procedure"](#).
NO >> INSPECTION END

Diagnosis Procedure

INFOID:000000007467304

1. CHECK STARTER RELAY OUTPUT SIGNAL

1. Turn ignition switch OFF.
2. Disconnect BCM connector.
3. Check voltage between BCM harness connector and ground.

(+)		(-)	Condition	Voltage (V) (Approx.)	
BCM					
Connector	Terminal				
M121	52	Ground	Selector lever (A/T models)	P or N position	12
				Other than above	0
			Clutch pedal (M/T models)	Depressed	Battery voltage
				Not depressed	0

Is the inspection result normal?

B210E STARTER RELAY

< DTC/CIRCUIT DIAGNOSIS >

- YES >> GO TO 3.
NO >> GO TO 2.

2.CHECK STARTER RELAY OUTPUT SIGNAL CIRCUIT

1. Disconnect IPDM E/R connector.
2. Check continuity between BCM harness connector and IPDM E/R harness connector.

BCM		IPDM E/R		Continuity
Connector	Terminal	Connector	Terminal	
M121	52	E6	46	Existed

3. Check continuity between BCM harness connector and ground.

BCM		Ground	Continuity
Connector	Terminal		
M121	52		Not existed

Is the inspection result normal?

- YES >> Replace IPDM E/R. Refer to [PCS-31, "Removal and Installation"](#).
NO >> Repair or replace harness.

3.CHECK STARTER RELAY POWER SUPPLY CIRCUIT

1. Turn ignition switch OFF.
2. Disconnect IPDM E/R connector.
3. Check voltage between IPDM E/R harness connector and ground.

(+)		(-)	Voltage (V) (Approx.)
IPDM E/R			
Connector	Terminal		
E5	36	Ground	Battery voltage

Is the inspection result normal?

- YES >> GO TO 4.
NO >> Check harness for open or short between IPDM E/R and battery. Refer to [SEC-149, "Wiring Diagram - IPDM E/R -"](#).

4.REPLACE BCM

1. Replace BCM. Refer to [BCS-3, "ADDITIONAL SERVICE WHEN REPLACING CONTROL UNIT : Special Repair Requirement"](#).
2. Perform DTC CONFIRMATION PROCEDURE. Refer to [SEC-86, "DTC Logic"](#).

Is the inspection result normal?

- YES >> INSPECTION END
NO >> Replace IPDM E/R. Refer to [PCS-31, "Removal and Installation"](#).

B210F SHIFT POSITION/CLUTCH INTERLOCK SWITCH

< DTC/CIRCUIT DIAGNOSIS >

B210F SHIFT POSITION/CLUTCH INTERLOCK SWITCH

Description

INFOID:000000007467305

IPDM E/R confirms the shift position with the following signals.

- Transmission range switch
- Shift position signal from BCM (CAN)

DTC Logic

INFOID:000000007467306

DTC DETECTION LOGIC

NOTE:

If DTC B210F is displayed with DTC U1000, first perform the trouble diagnosis for DTC U1000. Refer to [SEC-32. "IPDM E/R : DTC Logic"](#)

DTC No.	Trouble diagnosis name	DTC detecting condition	Possible cause
B210F	INTER LOCK/PNP SW ON	IPDM E/R detects the difference between the signals below for 1 second or more. <ul style="list-style-type: none"> • Transmission range switch input signal • Shift position signal from BCM (CAN) 	<ul style="list-style-type: none"> • Harness or connectors (Transmission range switch circuit is open or shorted) • Transmission range switch • IPDM E/R • BCM

DTC CONFIRMATION PROCEDURE

1. PERFORM DTC CONFIRMATION PROCEDURE

1. Turn ignition switch ON under the following conditions and wait 1 second or more.
 - Selector lever is in the P or N position
 - Do not depress brake pedal
2. Check "Self-diagnostic result" using CONSULT.

Is DTC detected?

- YES >> Go to [SEC-88. "Diagnosis Procedure"](#).
NO >> INSPECTION END

Diagnosis Procedure

INFOID:000000007467307

1. CHECK DTC WITH BCM

Check "Self-diagnostic result" using CONSULT. Refer to [SEC-139. "DTC Index"](#).

Is the inspection result normal?

- YES >> GO TO 2.
NO >> Repair or replace the malfunctioning parts.

2. CHECK TRANSMISSION RANGE SWITCH SIGNAL

1. Turn ignition switch OFF.
2. Disconnect IPDM E/R connector.
3. Turn ignition switch ON.
4. Check voltage between IPDM E/R harness connector and ground.

(+)		(-)	Condition	Voltage (V) (Approx.)	
IPDM E/R					
Connector	Terminal				
E5	30	Ground	Selector lever (A/T models)	N or P position	Battery voltage
				Other than above	0
			Clutch pedal (M/T models)	Depressed	Battery voltage
				Not depressed	0

Is the inspection result normal?

- YES >> Replace IPDM E/R. Refer to [PCS-31. "Removal and Installation"](#).

B210F SHIFT POSITION/CLUTCH INTERLOCK SWITCH

< DTC/CIRCUIT DIAGNOSIS >

NO >> GO TO 3.

3. CHECK TRANSMISSION RANGE SWITCH SIGNAL CIRCUIT

1. Disconnect BCM connector.
2. Check continuity between IPDM E/R harness connector and BCM harness connector.

IPDM E/R		BCM		Continuity
Connector	Terminal	Connector	Terminal	
E5	30	M123	140	Existed

3. Check continuity between IPDM E/R harness connector and ground.

IPDM E/R		Ground	Continuity
Connector	Terminal		
E5	30		Not existed

Is the inspection result normal?

- YES >> Replace BCM. Refer to [BCS-80, "Removal and Installation"](#).
NO >> Repair or replace harness.

A
B
C
D
E
F
G
H
I
J
L
M
N
O
P

SEC

B2110 SHIFT POSITION/CLUTCH INTERLOCK SWITCH

< DTC/CIRCUIT DIAGNOSIS >

B2110 SHIFT POSITION/CLUTCH INTERLOCK SWITCH

Description

INFOID:000000007467308

IPDM E/R confirms the shift position with the following signals.

- Transmission range switch
- Shift position signal from BCM (CAN)

DTC Logic

INFOID:000000007467309

DTC DETECTION LOGIC

NOTE:

If DTC B2110 is displayed with DTC U1000, first perform the trouble diagnosis for DTC U1000. Refer to [SEC-32, "IPDM E/R : DTC Logic"](#).

DTC No.	Trouble diagnosis name	DTC detecting condition	Possible cause
B2110	INTER LOCK/PNP SW	IPDM E/R detects the difference between the signals below for 1 second or more. <ul style="list-style-type: none">• Transmission range switch input signal• Shift position signal from BCM (CAN)	<ul style="list-style-type: none">• Harness or connectors (Transmission range switch circuit is open or shorted)• Transmission range switch• IPDM E/R• BCM

DTC CONFIRMATION PROCEDURE

1. PERFORM DTC CONFIRMATION PROCEDURE

1. Turn the ignition switch ON under the following conditions and wait 1 second or more.

A/T models

- Selector lever is in the P or N position
- Do not depress brake pedal

M/T models

- Do not depress clutch pedal
2. Check "Self-diagnostic result" using CONSULT.

Is DTC detected?

- YES >> Go to [SEC-90, "Diagnosis Procedure"](#).
NO >> INSPECTION END

Diagnosis Procedure

INFOID:000000007467310

1. CHECK DTC WITH BCM

Check "Self-diagnostic result" using CONSULT. Refer to [SEC-139, "DTC Index"](#).

Is the inspection result normal?

- YES >> GO TO 2.
NO >> Repair or replace the malfunctioning parts.

2. CHECK TRANSMISSION RANGE SWITCH SIGNAL

1. Turn ignition switch OFF.
2. Disconnect IPDM E/R connector.
3. Turn ignition switch ON.
4. Check voltage between IPDM E/R harness connector and ground.

B2110 SHIFT POSITION/CLUTCH INTERLOCK SWITCH

< DTC/CIRCUIT DIAGNOSIS >

(+)		(-)	Condition		Voltage (V) (Approx.)
IPDM E/R					
Connector	Terminal				
E5	30	Ground	Selector lever (A/T models)	N or P position	Battery voltage
				Other than above	0
			Clutch pedal (M/T models)	Depressed	Battery voltage
				Not depressed	0

Is the inspection result normal?

YES >> Replace IPDM E/R. Refer to [PCS-31. "Removal and Installation"](#).

NO >> GO TO 3.

3. CHECK TRANSMISSION RANGE SWITCH SIGNAL CIRCUIT

1. Disconnect BCM connector.
2. Check continuity between IPDM E/R harness connector and BCM harness connector.

IPDM E/R		BCM		Continuity
Connector	Terminal	Connector	Terminal	
E5	30	M123	140	Existed

3. Check continuity between IPDM E/R harness connector and ground.

IPDM E/R		Ground	Continuity
Connector	Terminal		
E5	30		Not existed

Is the inspection result normal?

YES >> Replace BCM. Refer to [BCS-80. "Removal and Installation"](#).

NO >> Repair or replace harness.

A
B
C
D
E
F
G
H
I
J
L
M
N
O
P

SEC

POWER SUPPLY AND GROUND CIRCUIT

< DTC/CIRCUIT DIAGNOSIS >

POWER SUPPLY AND GROUND CIRCUIT

BCM

BCM : Diagnosis Procedure

INFOID:000000007467311

1. CHECK FUSE AND FUSIBLE LINK

Check that the following fuse and fusible link are not blown.

Signal name	Fuse and fusible link No.
Battery power supply	K
	10

Is the fuse fusing?

- YES >> Replace the blown fuse or fusible link after repairing the affected circuit if a fuse or fusible link is blown.
NO >> GO TO 2.

2. CHECK POWER SUPPLY CIRCUIT

1. Turn ignition switch OFF.
2. Disconnect BCM connectors.
3. Check voltage between BCM harness connector and ground.

Terminals		Voltage (Approx.)
(+)	(-)	
BCM		Ground Battery voltage
Connector	Terminal	
M118	1	
M119	11	

Is the measurement value normal?

- YES >> GO TO 3.
NO >> Repair harness or connector.

3. CHECK GROUND CIRCUIT

Check continuity between BCM harness connector and ground.

BCM		Ground	Continuity
Connector	Terminal		Existed
M119	13		

Does continuity exist?

- YES >> INSPECTION END
NO >> Repair harness or connector.

IPDM E/R

IPDM E/R : Diagnosis Procedure

INFOID:000000007467312

1. CHECK FUSES AND FUSIBLE LINK

Check that the following IPDM E/R fuses or fusible links are not blown.

Signal name	Fuses and fusible link No.
Battery power supply	C
	50
	51

POWER SUPPLY AND GROUND CIRCUIT

< DTC/CIRCUIT DIAGNOSIS >

Is the fuse fusing?

- YES >> Replace the blown fuse or fusible link after repairing the affected circuit if a fuse or fusible link is blown.
- NO >> GO TO 2.

2.CHECK POWER SUPPLY CIRCUIT

1. Turn the ignition switch OFF.
2. Disconnect IPDM E/R connector.
3. Check voltage between IPDM E/R harness connector and the ground.

Terminals		Voltage (Approx.)
(+)	(-)	
IPDM E/R		Battery voltage
Connector	Terminal	
E4	1	
	2	

Is the measurement value normal?

- YES >> GO TO 3.
- NO >> Repair the harness or connector.

3.CHECK GROUND CIRCUIT

Check continuity between IPDM E/R harness connectors and the ground.

IPDM E/R		Ground	Continuity
Connector	Terminal		
E5	12		Existed
E6	41		

Does continuity exist?

- YES >> INSPECTION END
- NO >> Repair the harness or connector.

A
B
C
D
E
F
G
H
I
J
L
M
N
O
P

SEC

KEY SLOT

< DTC/CIRCUIT DIAGNOSIS >

KEY SLOT

Description

INFOID:000000007467313

When the Intelligent Key battery is discharged, it performs the NVIS (NATS) ID verification between the integrated transponder and BCM by inserting the Intelligent Key into the key slot, and then the engine can be started.

Component Function Check

INFOID:000000007467314

1. CHECK FUNCTION

1. Remove Intelligent Key battery from Intelligent Key.
2. Change power supply position when Intelligent Key insert into key slot and then press push-button ignition switch.

Is the inspection result normal?

- YES >> Key slot function is normal.
NO >> Go to [SEC-94, "Diagnosis Procedure"](#).

Diagnosis Procedure

INFOID:000000007467315

1. CHECK KEY SLOT POWER SUPPLY CIRCUIT

1. Turn ignition switch OFF.
2. Disconnect key slot connector.
3. Check voltage between key slot harness connector and ground.

(+)		(-)	Voltage (V) (Approx.)
Key slot			
Connector	Terminal	Ground	Battery voltage
M22	1		
	5		

Is the inspection result normal?

- YES >> GO TO 2.
NO-1 >> Check 10 A fuse [No. 6 and 9 located in the fuse block (J/B)].
NO-2 >> Check harness for open or short between key slot and fuse.

2. CHECK KEY SLOT GROUND CIRCUIT

Check continuity between key slot harness connector and ground.

Key slot		Ground	Continuity
Connector	Terminal		
M22	7		Existed

Is the inspection result normal?

- YES >> Replace key slot. Refer to [SEC-162, "Removal and Installation"](#).
NO >> Repair or replace harness.

KEY SLOT INDICATOR

< DTC/CIRCUIT DIAGNOSIS >

KEY SLOT INDICATOR

Description

INFOID:000000007467316

Blinks when Intelligent Key insertion is required.

Component Function Check

INFOID:000000007467317

1.CHECK FUNCTION

Check key slot illumination ("KEY SLOT ILLUMI") Active Test mode.

Is the inspection result normal?

- YES >> Key slot function is normal.
NO >> Refer to [SEC-95. "Diagnosis Procedure"](#).

Diagnosis Procedure

INFOID:000000007467318

1.CHECK KEY SLOT INDICATOR OUTPUT SIGNAL

Check voltage between key slot harness connector and ground.

Key slot (+)		(-)	Condition	Key slot illumination	Voltage (V) (Approx.)
Connector	Terminal				
M22	6	Ground	Insert Intelligent Key into key slot	OFF	Battery voltage
			Remove Intelligent Key from key slot	ON	0

Is the inspection result normal?

- YES >> GO TO 5.
NO >> GO TO 2.

2.CHECK KEY SLOT POWER SUPPLY CIRCUIT

1. Turn ignition switch OFF.
2. Disconnect key slot connector.
3. Check voltage between key slot harness connector and ground.

Key slot (+)		(-)	Voltage (V) (Approx.)
Connector	Terminal		
M22	1	Ground	Battery voltage
	5		

Is the inspection result normal?

- YES >> GO TO 3.
NO-1 >> Check 10 A fuse [No. 6 and 9 located in the fuse block (J/B)].
NO-2 >> Check harness for open or short between key slot and fuse.

3.CHECK KEY SLOT GROUND CIRCUIT

Check continuity between key slot harness connector and ground.

Key slot		Ground	Continuity
Connector	Terminal		
M22	7		Existed

Is the inspection result normal?

- YES >> GO TO 4.

A
B
C
D
E
F
G
H
I
J
L
M
N
O
P

SEC

KEY SLOT INDICATOR

< DTC/CIRCUIT DIAGNOSIS >

NO >> Repair or replace key slot ground circuit.

4.CHECK KEY SLOT CIRCUIT

1. Turn ignition switch OFF.
2. Disconnect BCM connector.
3. Check continuity between BCM harness connector and key slot harness connector.

BCM		Key slot		Continuity
Connector	Terminal	Connector	Terminal	
M122	92	M22	6	Existed

4. Check continuity between BCM harness connector and ground.

BCM		Ground	Continuity
Connector	Terminal		
M122	92		Not existed

Is the inspection result normal?

YES >> Replace key slot. Refer to [SEC-162. "Removal and Installation"](#).

NO >> Repair or replace harness.

5.CHECK INTERMITTENT INCIDENT

Refer to [GI-43. "Intermittent Incident"](#).

>> INSPECTION END

HOOD SWITCH

< DTC/CIRCUIT DIAGNOSIS >

HOOD SWITCH

Description

INFOID:000000007467319

Hood switch is built into hood lock (RH) and connected to IPDM E/R which detects the open/close condition of hood.

Component Function Check

INFOID:000000007467320

1.CHECK FUNCTION

1. Select "HOOD SW" in the "Data Monitor" mode using CONSULT.
2. Check the hood switch signal under the following condition.

Test item	Condition		Status
HOOD SW	Hood	Open	ON
		Close	OFF

Is the indication normal?

- YES >> Hood switch is normal.
NO >> Go to [SEC-97. "Diagnosis Procedure"](#).

Diagnosis Procedure

INFOID:000000007467321

1.CHECK HOOD SWITCH SIGNAL

1. Turn ignition switch OFF.
2. Disconnect hood switch connector.
3. Check voltage between hood switch harness connector and ground.

(+)		(-)	Voltage (V) (Approx.)
Hood switch			
Connector	Terminal		
E30	2	Ground	Battery voltage

Is the inspection result normal?

- YES >> GO TO 3.
NO >> GO TO 2.

2.CHECK HOOD SWITCH CIRCUIT

1. Disconnect IPDM E/R connector.
2. Check continuity between IPDM E/R harness connector and hood switch harness connector.

IPDM E/R		Hood switch		Continuity
Connector	Terminal	Connector	Terminal	
E9	104	E30	2	Existed

3. Check continuity between IPDM E/R harness connector and ground.

IPDM E/R		Ground	Continuity
Connector	Terminal		
E9	104		Not existed

Is the inspection result normal?

- YES >> Replace IPDM E/R. Refer to [PCS-31. "Removal and Installation"](#).
NO >> Repair or replace harness.

3.CHECK HOOD SWITCH GROUND CIRCUIT

Check continuity between hood switch harness connector and ground.

HOOD SWITCH

< DTC/CIRCUIT DIAGNOSIS >

Hood switch		Ground	Continuity
Connector	Terminal		
E30	1		Existed

Is the inspection result normal?

- YES >> GO TO 4.
 NO >> Repair or replace harness.

4.CHECK HOOD SWITCH

Refer to [SEC-98, "Component Inspection"](#).

Is the inspection result normal?

- YES >> GO TO 5.
 NO >> Replace hood lock (RH). Refer to [DLK-201, "HOOD LOCK CONTROL : Exploded View"](#).

5.CHECK INTERMITTENT INCIDENT

Refer to [GI-43, "Intermittent Incident"](#).

>> INSPECTION END

Component Inspection

INFOID:000000007467322

1.CHECK HOOD SWITCH

1. Turn ignition switch OFF.
2. Disconnect hood switch connector.
3. Check continuity between hood switch terminals.

Hood switch		Condition	Continuity
Terminal			
1	2	Hood switch	Pressed
			Released
			Not existed
			Existed

Is the inspection result normal?

- YES >> INSPECTION END
 NO >> Replace hood lock (RH). Refer to [DLK-201, "HOOD LOCK CONTROL : Exploded View"](#).

SECURITY INDICATOR LAMP

< DTC/CIRCUIT DIAGNOSIS >

SECURITY INDICATOR LAMP

Description

INFOID:000000007467323

- Security indicator lamp is located on combination meter.
- IVIS (Nissan Vehicle Immobilizer System) and vehicle security system conditions are indicated by blink or illumination of security indicator lamp.

Component Function Check

INFOID:000000007467324

1. CHECK FUNCTION

1. Perform "THEFT IND" in the "ACTIVE TEST" mode with CONSULT.
2. Check security indicator lamp operation.

Test item		Description	
THEFT IND	ON	Security indicator lamp	Illuminates
	OFF		Does not illuminate

Is the inspection result normal?

- YES >> INSPECTION END
NO >> Go to [SEC-99, "Diagnosis Procedure"](#).

Diagnosis Procedure

INFOID:000000007467325

1. CHECK SECURITY INDICATOR LAMP POWER SUPPLY CIRCUIT

1. Turn ignition switch OFF.
2. Disconnect combination meter connector.
3. Check voltage between combination meter harness connector and ground.

(+)		(-)	Voltage (V) (Approx.)
Combination meter			
Connector	Terminal	Ground	Battery voltage
M53	1		

Is the inspection result normal?

- YES >> GO TO 2.
NO-1 >> 10A fuse [No. 11, located in the fuse block (J/B)].
NO-2 >> Harness for open or short between combination meter and fuse.

2. CHECK SECURITY INDICATOR LAMP SIGNAL

1. Connect combination meter connector.
2. Disconnect BCM connector.
3. Check voltage between BCM harness connector and ground.

(+)		(-)	Voltage (V) (Approx.)
BCM			
Connector	Terminal	Ground	Battery voltage
M123	141		

Is the inspection result normal?

- YES >> Replace BCM. Refer to [BCS-80, "Removal and Installation"](#).
NO >> GO TO 3.

3. CHECK COMBINATION METER CIRCUIT

1. Disconnect BCM connector.
2. Check continuity between combination meter harness connector and BCM harness connector.

SECURITY INDICATOR LAMP

< DTC/CIRCUIT DIAGNOSIS >

Combination meter		BCM		Continuity
Connector	Terminal	Connector	Terminal	
M53	10	M123	141	Existed

3. Check continuity between combination meter harness connector and ground.

Combination meter		Ground	Continuity
Connector	Terminal		
M53	10		Not existed

Is the inspection result normal?

- YES >> Replace combination meter. Refer to [MWI-113, "Removal and Installation"](#).
NO >> Repair or replace harness.

KEY WARNING LAMP

< DTC/CIRCUIT DIAGNOSIS >

KEY WARNING LAMP

Description

INFOID:000000007467326

Performs operation method guide and warning together with buzzer.

Component Function Check

INFOID:000000007467327

1.CHECK FUNCTION

Check the operation with "INDICATOR" in "Active Test" mode using CONSULT.

Test item	Condition	
INDICATOR	KEY ON	Key warning lamp illuminates
	KEY IND	Key warning lamp blinks

Is the inspection result normal?

YES >> Key warning lamp in combination meter is normal.

NO >> Refer to [SEC-101, "Diagnosis Procedure"](#).

Diagnosis Procedure

INFOID:000000007467328

1.CHECK KEY WARNING LAMP

Refer to [DLK-110, "Component Function Check"](#).

Is the inspection result normal?

YES >> GO TO 2.

NO >> Repair or replace harness.

2.CHECK INTERMITTENT INCIDENT

Refer to [GI-43, "Intermittent Incident"](#).

>> INSPECTION END

A
B
C
D
E
F
G
H
I
J
L
M
N
O
P

SEC

INTELLIGENT KEY SYSTEM/ENGINE START FUNCTION

< DTC/CIRCUIT DIAGNOSIS >

INTELLIGENT KEY SYSTEM/ENGINE START FUNCTION

Wiring Diagram - INTELLIGENT KEY SYSTEM/ENGINE START FUNCTION -

INFOID:000000007467329

For connector terminal arrangements, harness layouts, and alphabets in a  (option abbreviation; if not described in wiring diagram), refer to [GI-12, "Connector Information"](#).

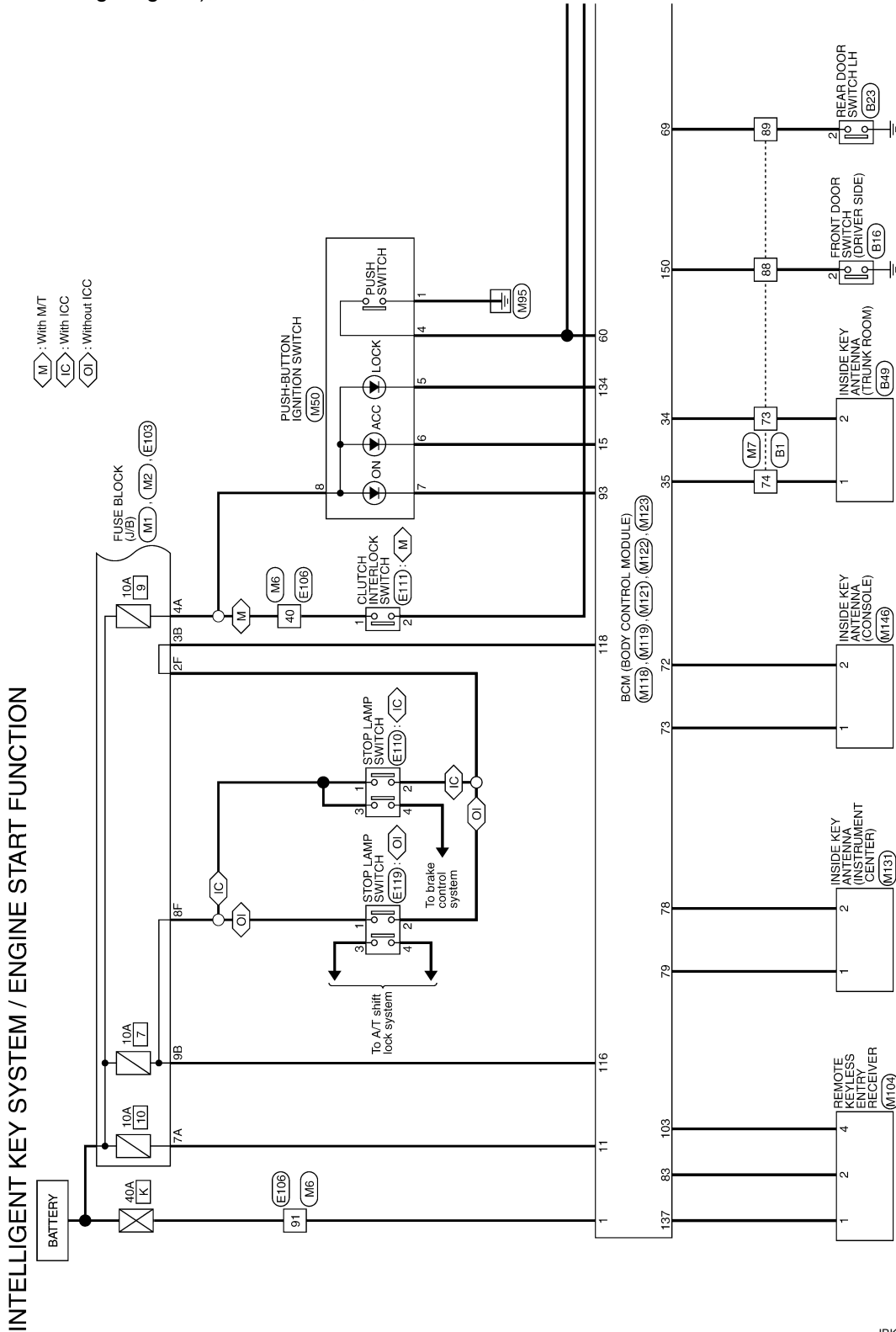

2011/07/07

JRKCWC0856GB

INTELLIGENT KEY SYSTEM/ENGINE START FUNCTION

< DTC/CIRCUIT DIAGNOSIS >

- : With A/T
- : With M/T
- : With ICC
- : Without ICC

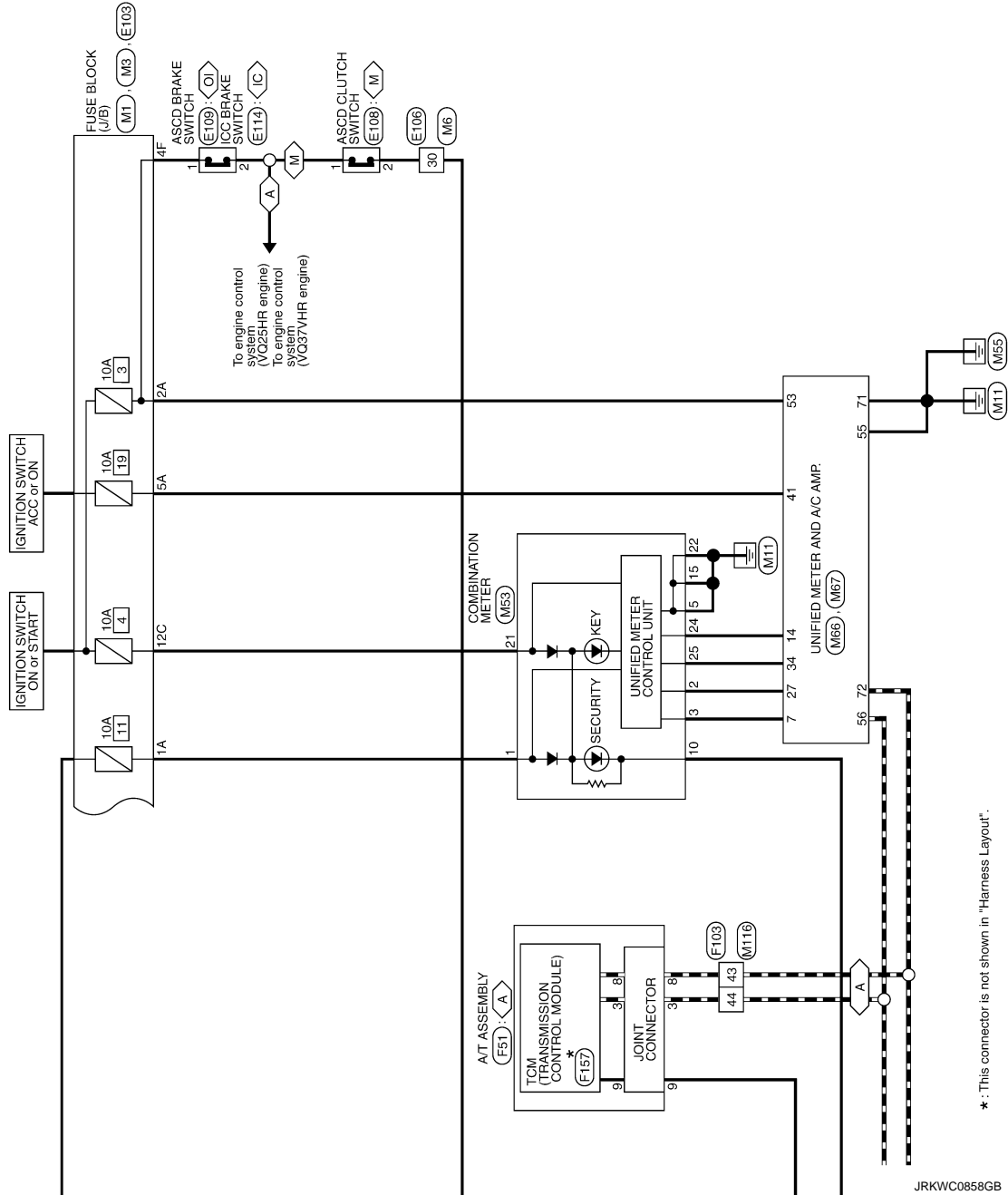

INFINITI VEHICLE IMMOBILIZER SYSTEM-NATS

< DTC/CIRCUIT DIAGNOSIS >

INFINITI VEHICLE IMMOBILIZER SYSTEM-NATS

Wiring Diagram - IVIS -

INFOID:000000007467330

For connector terminal arrangements, harness layouts, and alphabets in a  (option abbreviation; if not described in wiring diagram), refer to [GI-12, "Connector Information"](#).

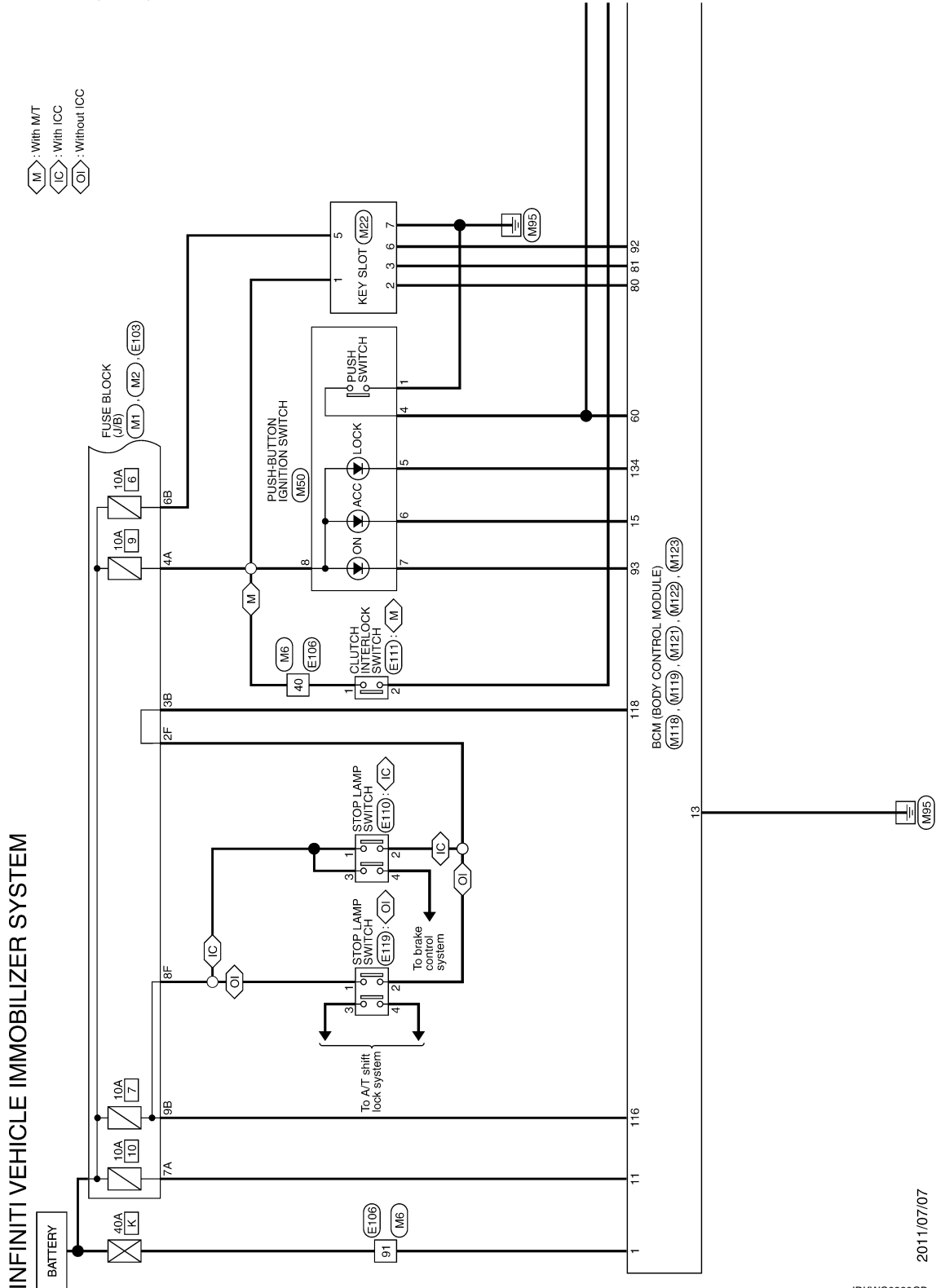

A
B
C
D
E
F
G
H
I
J
L
M
N
O
P

SEC

2011/07/07

JRWKC0860GB

INFINITI VEHICLE IMMOBILIZER SYSTEM-NATS

< DTC/CIRCUIT DIAGNOSIS >

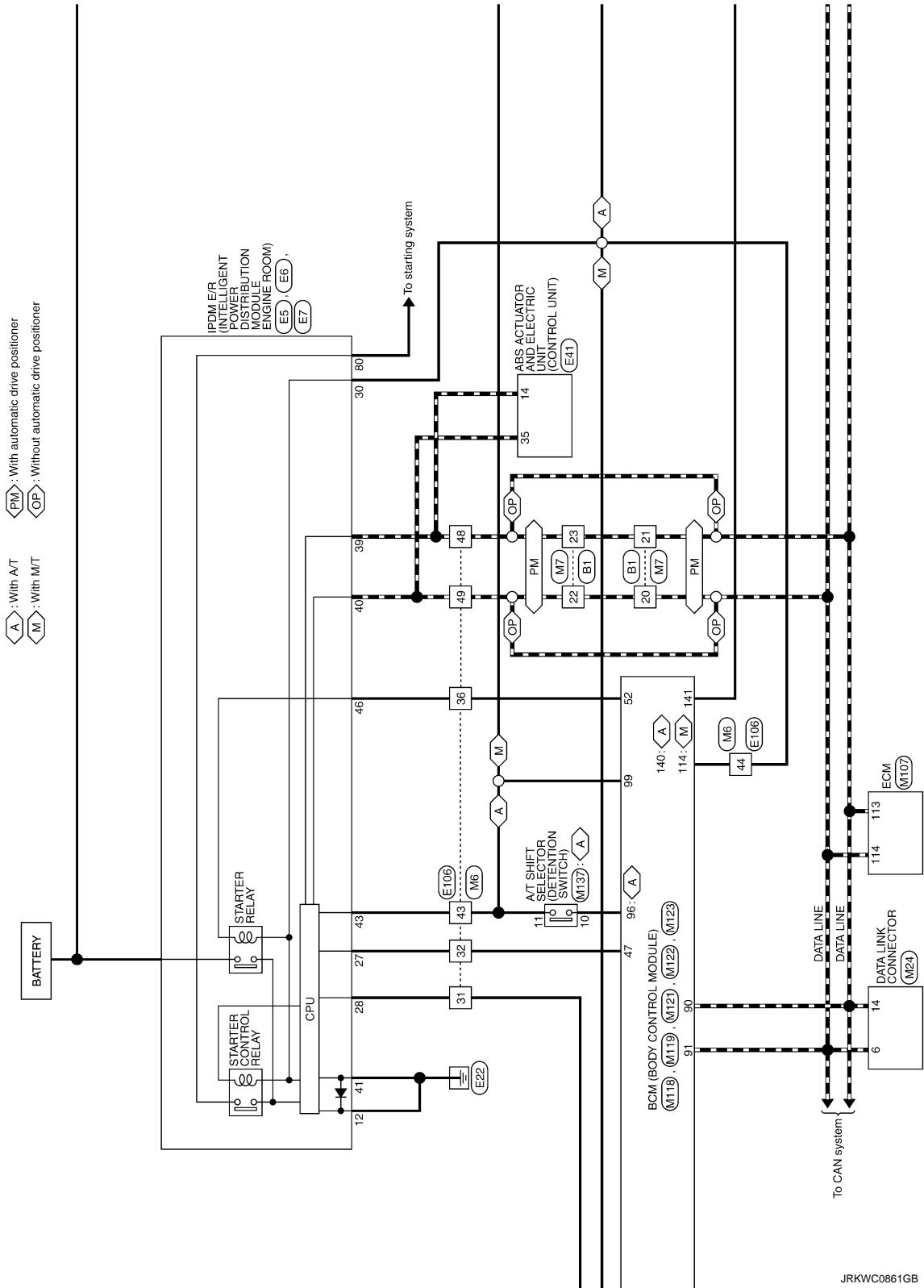

JRKWC0861GB

INFINITI VEHICLE IMMOBILIZER SYSTEM-NATS

< DTC/CIRCUIT DIAGNOSIS >

- ◊ A : With A/T
- ◊ M : With M/T
- ◊ V2 : With VQ25HR engine
- ◊ V3 : With VQ37VHR engine
- ◊ IC : With ICC
- ◊ OI : Without ICC

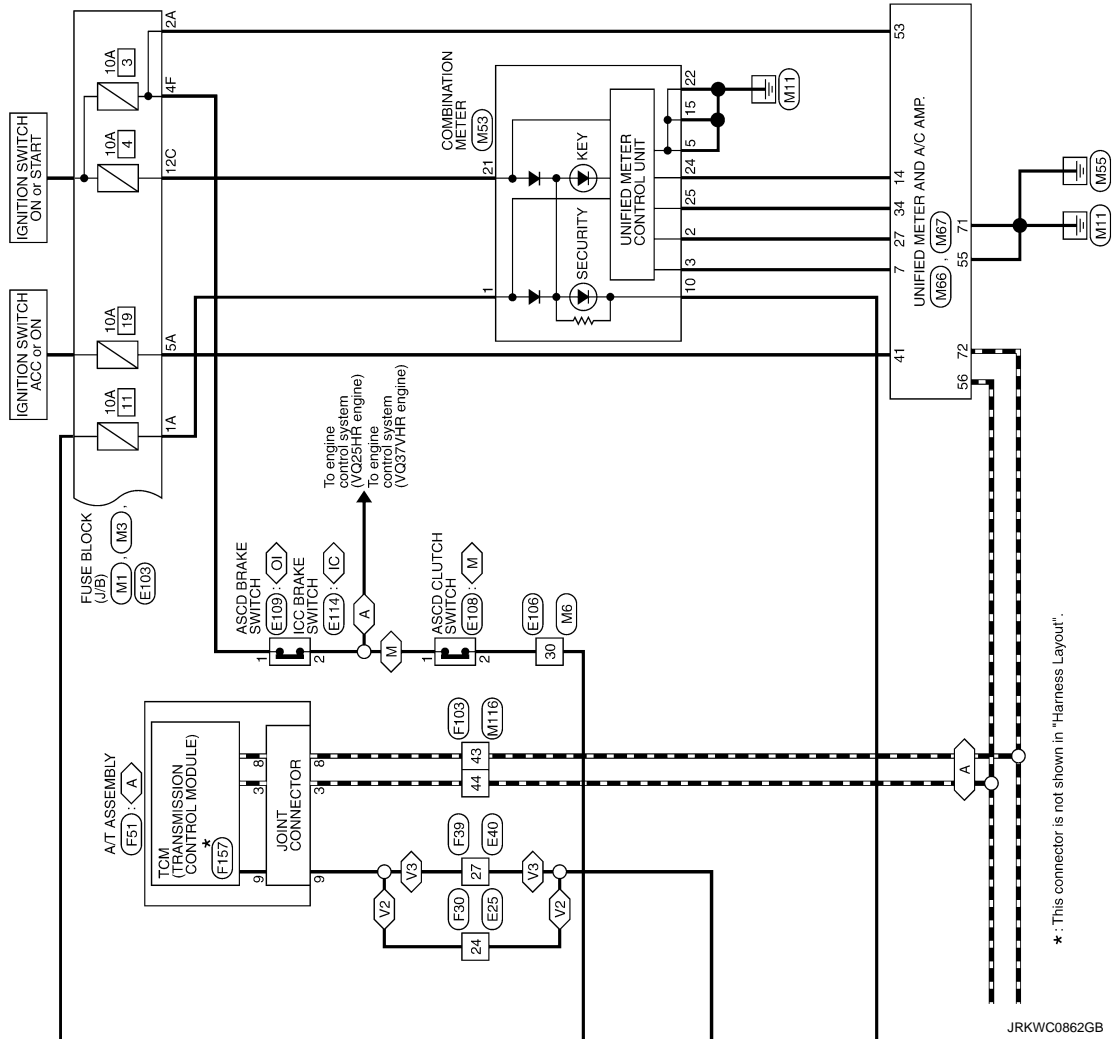

JRKWC0862GB

A
B
C
D
E
F
G
H
I
J
K
L
M
N
O
P

SEC

VEHICLE SECURITY SYSTEM

< DTC/CIRCUIT DIAGNOSIS >

VEHICLE SECURITY SYSTEM

Wiring Diagram - VEHICLE SECURITY SYSTEM -

INFOID:000000007467331

For connector terminal arrangements, harness layouts, and alphabets in a  (option abbreviation; if not described in wiring diagram), refer to [GI-12, "Connector Information"](#).

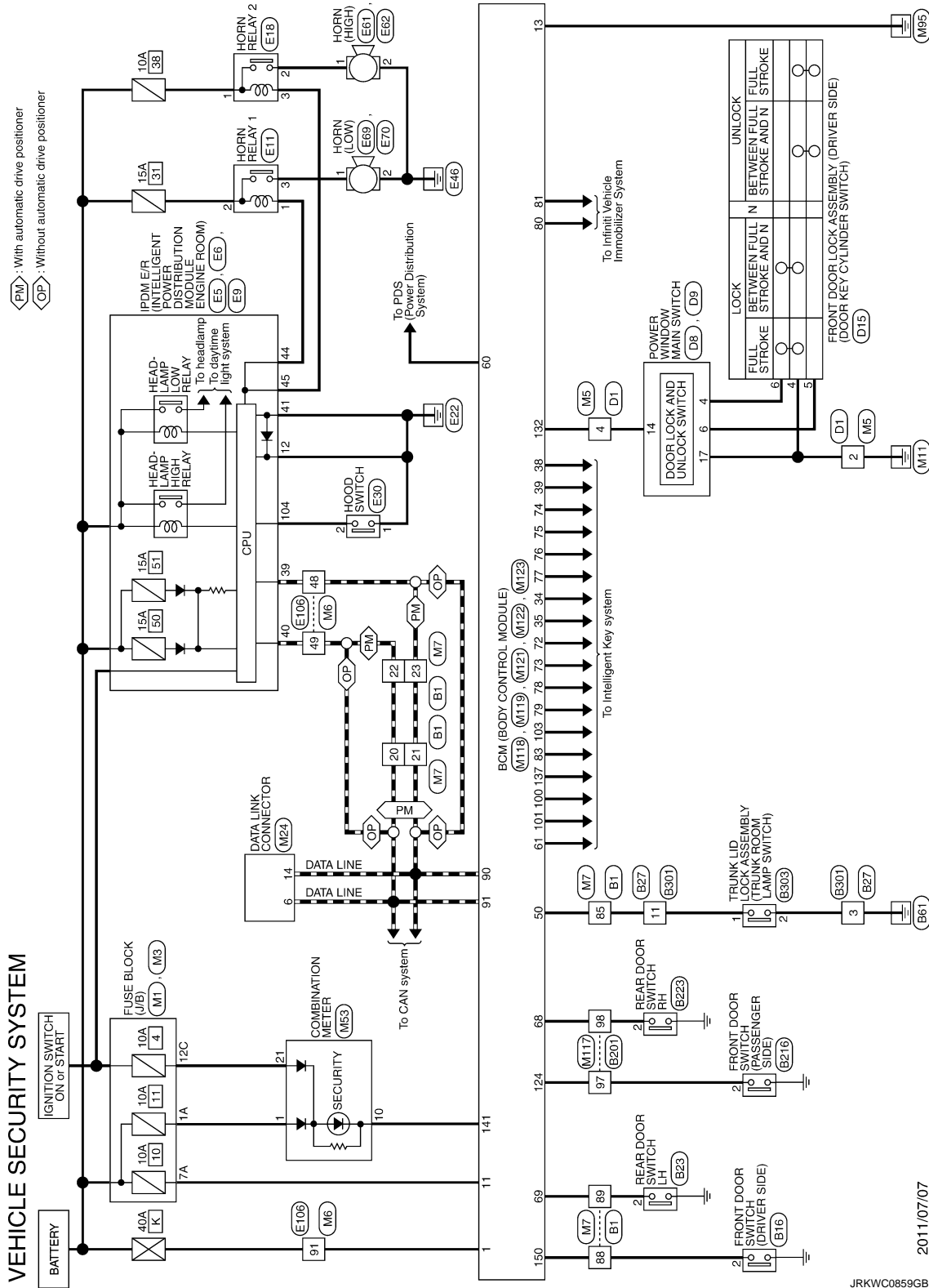

BCM

< ECU DIAGNOSIS INFORMATION >

ECU DIAGNOSIS INFORMATION

BCM

Reference Value

INFOID:000000007753446

VALUES ON THE DIAGNOSIS TOOL

CONSULT MONITOR ITEM

Monitor Item	Condition	Value/Status
FR WIPER HI	Other than front wiper switch HI	Off
	Front wiper switch HI	On
FR WIPER LOW	Other than front wiper switch LO	Off
	Front wiper switch LO	On
FR WASHER SW	Front washer switch OFF	Off
	Front washer switch ON	On
FR WIPER INT	Other than front wiper switch INT/AUTO	Off
	Front wiper switch INT/AUTO	On
FR WIPER STOP	Front wiper is not in STOP position	Off
	Front wiper is in STOP position	On
INT VOLUME	Wiper volume dial is in a dial position 1 - 7	Wiper volume dial position
TURN SIGNAL R	Other than turn signal switch RH	Off
	Turn signal switch RH	On
TURN SIGNAL L	Other than turn signal switch LH	Off
	Turn signal switch LH	On
TAIL LAMP SW	Other than lighting switch 1ST and 2ND	Off
	Lighting switch 1ST or 2ND	On
HI BEAM SW	Other than lighting switch HI	Off
	Lighting switch HI	On
HEAD LAMP SW 1	Other than lighting switch 2ND	Off
	Lighting switch 2ND	On
HEAD LAMP SW 2	Other than lighting switch 2ND	Off
	Lighting switch 2ND	On
PASSING SW	Other than lighting switch PASS	Off
	Lighting switch PASS	On
AUTO LIGHT SW	Other than lighting switch AUTO	Off
	Lighting switch AUTO	On
FR FOG SW	Front fog lamp switch OFF	Off
	Front fog lamp switch ON	On
RR FOG SW	NOTE: The item is indicated, but not monitored.	Off
DOOR SW-DR	Driver door closed	Off
	Driver door opened	On
DOOR SW-AS	Passenger door closed	Off
	Passenger door opened	On
DOOR SW-RR	Rear RH door closed	Off
	Rear LH door opened	On

BCM

< ECU DIAGNOSIS INFORMATION >

Monitor Item	Condition	Value/Status
DOOR SW-RL	Rear LH door closed	Off
	Rear LH door opened	On
DOOR SW-BK	NOTE: The item is indicated, but not monitored.	Off
CDL LOCK SW	Other than power door lock switch LOCK	Off
	Power door lock switch LOCK	On
CDL UNLOCK SW	Other than power door lock switch UNLOCK	Off
	Power door lock switch UNLOCK	On
KEY CYL LK-SW	Other than driver door key cylinder LOCK	Off
	Driver door key cylinder LOCK	On
KEY CYL UN-SW	Other than driver door key cylinder UNLOCK	Off
	Driver door key cylinder LOCK	On
KEY CYL SW-TR	NOTE: The item is indicated, but not monitored.	Off
HAZARD SW	Hazard switch is OFF	Off
	Hazard switch is ON	On
REAR DEF SW	NOTE: The item is indicated, but not monitored.	Off
TR CANCEL SW	Trunk lid opener cancel switch OFF	Off
	Trunk lid opener cancel switch ON	On
TR/BD OPEN SW	Trunk lid opener switch OFF	Off
	While the trunk lid opener switch is turned ON	On
TRNK/HAT MNTR	Trunk lid closed	Off
	Trunk lid opened	On
REVERSE SW	NOTE: The item is indicated, but not monitored.	Off
RKE-LOCK	LOCK button of the Intelligent Key is not pressed	Off
	LOCK button of the Intelligent Key is pressed	On
RKE-UNLOCK	UNLOCK button of the Intelligent Key is not pressed	Off
	UNLOCK button of the Intelligent Key is pressed	On
RKE-TR/BD	TRUNK OPEN button of the Intelligent Key is not pressed	Off
	TRUNK OPEN button of the Intelligent Key is pressed	On
RKE-PANIC	PANIC button of the Intelligent Key is not pressed	Off
	PANIC button of the Intelligent Key is pressed	On
RKE-P/W OPEN	UNLOCK button of the Intelligent Key is not pressed	Off
	UNLOCK button of the Intelligent Key is pressed and held	On
RKE-MODE CHG	LOCK/UNLOCK button of the Intelligent Key is not pressed and held simultaneously	Off
	LOCK/UNLOCK button of the Intelligent Key is pressed and held simultaneously	On
OPTICAL SENSOR	Bright outside of the vehicle	Close to 5 V
	Dark outside of the vehicle	Close to 0 V
REQ SW -DR	Driver door request switch is not pressed	Off
	Driver door request switch is pressed	On
REQ SW -AS	Passenger door request switch is not pressed	Off
	Passenger door request switch is pressed	On

BCM

< ECU DIAGNOSIS INFORMATION >

Monitor Item	Condition	Value/Status	
REQ SW -RR	NOTE: The item is indicated, but not monitored.	Off	A
REQ SW -RL	NOTE: The item is indicated, but not monitored.	Off	B
REQ SW -BD/TR	Trunk lid opener request switch is not pressed	Off	C
	Trunk lid opener request switch is pressed	On	
PUSH SW	Push-button ignition switch (push switch) is not pressed	Off	D
	Push-button ignition switch (push switch) is pressed	On	
IGN RLY2 -F/B	NOTE: The item is indicated, but not monitored.	Off	E
ACC RLY -F/B	NOTE: The item is indicated, but not monitored.	Off	F
CLUCH SW	The clutch pedal is not depressed	Off	G
	The clutch pedal is depressed	On	
BRAKE SW 1	The brake pedal is depressed when No. 7 fuse is blown	Off	H
	The brake pedal is not depressed when No. 7 fuse is blown, or No. 7 fuse is normal	On	
BRAKE SW 2	The brake pedal is not depressed	Off	I
	The brake pedal is depressed	On	
DETE/CANCL SW	<ul style="list-style-type: none"> • Selector lever in P position (Except M/T models) • The clutch pedal is depressed (M/T models) 	Off	J
	<ul style="list-style-type: none"> • Selector lever in any position other than P (Except M/T models) • The clutch pedal is not depressed (M/T models) 	On	
SFT PN/N SW	Selector lever in any position other than P and N	Off	K
	Selector lever in P or N position	On	
S/L -LOCK	NOTE: The item is indicated, but not monitored.	Off	L
S/L -UNLOCK	NOTE: The item is indicated, but not monitored.	Off	SEC
S/L RELAY-F/B	NOTE: The item is indicated, but not monitored.	Off	M
UNLK SEN -DR	Driver door is unlocked	Off	N
	Driver door is locked	On	
PUSH SW -IPDM	Push-button ignition switch (push-switch) is not pressed	Off	O
	Push-button ignition switch (push-switch) is pressed	On	
IGN RLY1 -F/B	Ignition switch in OFF or ACC position	Off	P
	Ignition switch in ON position	On	
DETE SW -IPDM	Selector lever in any position other than P	Off	P
	Selector lever in P position	On	
SFT PN -IPDM	<ul style="list-style-type: none"> • Selector lever in any position other than P and N (Except M/T models) • The clutch pedal is not depressed (M/T models) 	Off	P
	<ul style="list-style-type: none"> • Selector lever in P or N position (Except M/T models) • The clutch pedal is depressed (M/T models) 	On	
SFT P -MET	Selector lever in any position other than P	Off	P
	Selector lever in P position	On	
SFT N -MET	Selector lever in any position other than N	Off	P
	Selector lever in N position	On	

BCM

< ECU DIAGNOSIS INFORMATION >

Monitor Item	Condition	Value/Status
ENGINE STATE	Engine stopped	Stop
	While the engine stalls	Stall
	At engine cranking	Crank
	Engine running	Run
S/L LOCK-IPDM	NOTE: The item is indicated, but not monitored.	Off
S/L UNLK-IPDM	NOTE: The item is indicated, but not monitored.	Off
S/L RELAY-REQ	NOTE: The item is indicated, but not monitored.	Off
VEH SPEED 1	While driving	Equivalent to speedometer reading
VEH SPEED 2	While driving	Equivalent to speedometer reading
DOOR STAT-DR	Driver door is locked	LOCK
	Wait with selective UNLOCK operation (60 seconds)	READY
	Driver door is unlocked	UNLOCK
DOOR STAT-AS	Passenger door is locked	LOCK
	Wait with selective UNLOCK operation (60 seconds)	READY
	Passenger door is unlocked	UNLOCK
ID OK FLAG	Driver side door is open after ignition switch is turned OFF (Shift position is in the P position)	Reset
	Ignition switch ON	Set
PRMT ENG STRT	The engine start is prohibited	Reset
	The engine start is permitted	Set
PRMT RKE STRT	NOTE: The item is indicated, but not monitored.	Reset
KEY SW -SLOT	The Intelligent Key is not inserted into key slot	Off
	The Intelligent Key is inserted into key slot	On
RKE OPE COUN1	During the operation of the Intelligent Key	Operation frequency of the Intelligent Key
RKE OPE COUN2	NOTE: The item is indicated, but not monitored.	—
CONFIRM ID ALL	The key ID that the key slot receives is not recognized by any key ID registered to BCM.	Yet
	The key ID that the key slot receives is recognized by any key ID registered to BCM.	Done
CONFIRM ID4	The key ID that the key slot receives is not recognized by the fourth key ID registered to BCM.	Yet
	The key ID that the key slot receives is recognized by the fourth key ID registered to BCM.	Done
CONFIRM ID3	The key ID that the key slot receives is not recognized by the third key ID registered to BCM.	Yet
	The key ID that the key slot receives is recognized by the third key ID registered to BCM.	Done
CONFIRM ID2	The key ID that the key slot receives is not recognized by the second key ID registered to BCM.	Yet
	The key ID that the key slot receives is recognized by the second key ID registered to BCM.	Done

BCM

< ECU DIAGNOSIS INFORMATION >

Monitor Item	Condition	Value/Status	
CONFIRM ID1	The key ID that the key slot receives is not recognized by the first key ID registered to BCM.	Yet	A
	The key ID that the key slot receives is recognized by the first key ID registered to BCM.	Done	B
TP 4	The ID of fourth Intelligent Key is not registered to BCM	Yet	C
	The ID of fourth Intelligent Key is registered to BCM	Done	
TP 3	The ID of third Intelligent Key is not registered to BCM	Yet	D
	The ID of third Intelligent Key is registered to BCM	Done	
TP 2	The ID of second Intelligent Key is not registered to BCM	Yet	E
	The ID of second Intelligent Key is registered to BCM	Done	
TP 1	The ID of first Intelligent Key is not registered to BCM	Yet	F
	The ID of first Intelligent Key is registered to BCM	Done	
AIR PRESS FL	Ignition switch ON (Only when the signal from the transmitter is received)	Air pressure of front LH tire	G
AIR PRESS FR	Ignition switch ON (Only when the signal from the transmitter is received)	Air pressure of front RH tire	H
AIR PRESS RR	Ignition switch ON (Only when the signal from the transmitter is received)	Air pressure of rear RH tire	I
AIR PRESS RL	Ignition switch ON (Only when the signal from the transmitter is received)	Air pressure of rear LH tire	J
ID REGST FL1	ID of front LH tire transmitter is registered	Done	K
	ID of front LH tire transmitter is not registered	Yet	
ID REGST FR1	ID of front RH tire transmitter is registered	Done	L
	ID of front RH tire transmitter is not registered	Yet	
ID REGST RR1	ID of rear RH tire transmitter is registered	Done	M
	ID of rear RH tire transmitter is not registered	Yet	
ID REGST RL1	ID of rear LH tire transmitter is registered	Done	N
	ID of rear LH tire transmitter is not registered	Yet	
WARNING LAMP	Tire pressure indicator OFF	Off	O
	Tire pressure indicator ON	On	
BUZZER	Tire pressure warning alarm is not sounding	Off	P
	Tire pressure warning alarm is sounding	On	

SEC

BCM

< ECU DIAGNOSIS INFORMATION >

TERMINAL LAYOUT

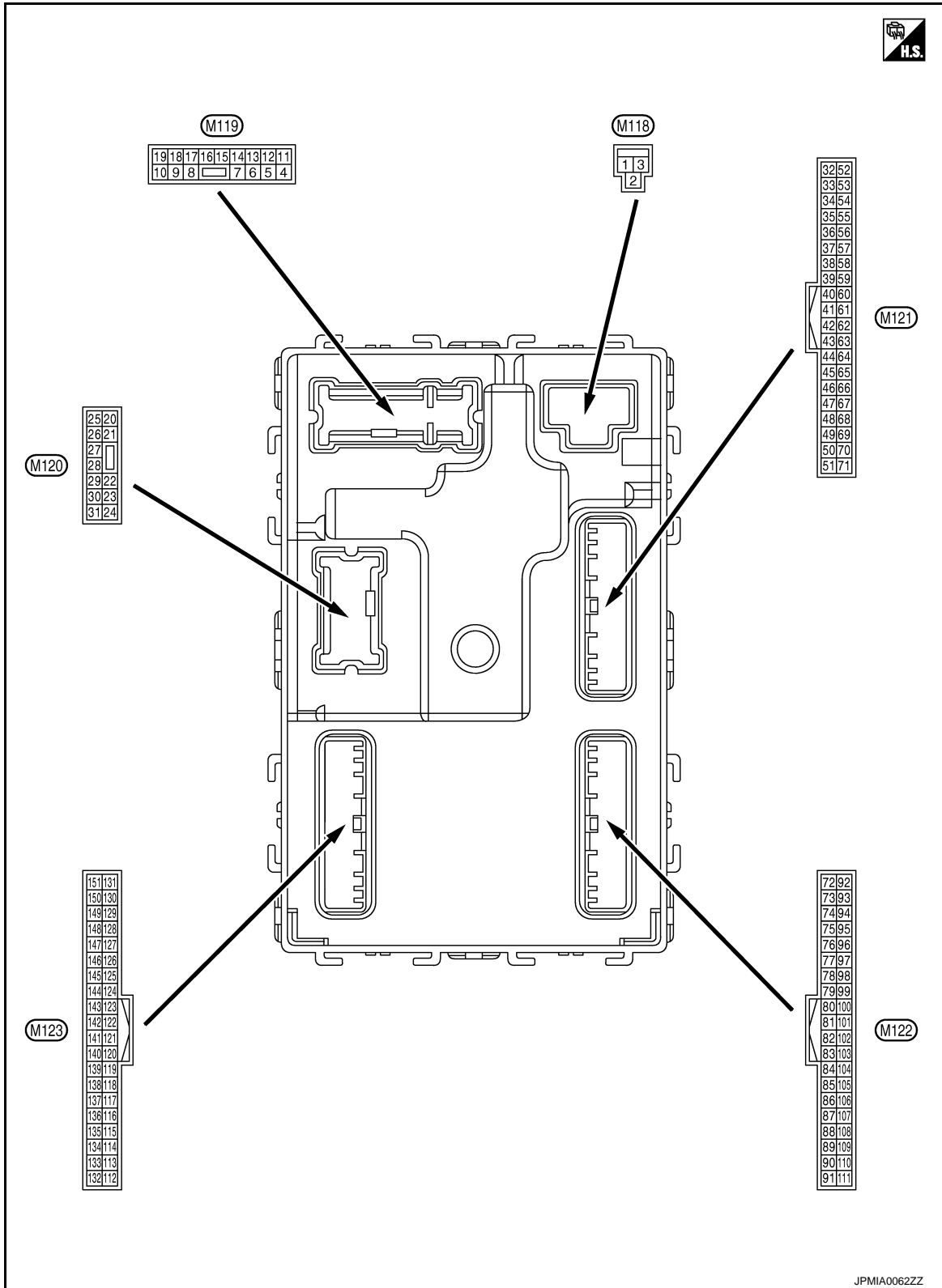

PHYSICAL VALUES

BCM

< ECU DIAGNOSIS INFORMATION >

Terminal No. (Wire color)		Description		Condition		Value (Approx.)	
		Signal name	Input/ Output				
+	-						
1 (W)	Ground	Battery power supply	Input	Ignition switch OFF		Battery voltage	A
2 (Y)	Ground	P/W power supply (BAT)	Output	Ignition switch OFF		12 V	B
3 (BG)	Ground	P/W power supply (RAP)	Output	Ignition switch ON		12 V	C
4 (LG)	Ground	Interior room lamp power supply	Output	Interior room lamp battery saver is activated. (Cuts the interior room lamp power supply)		0 V	D
				Interior room lamp battery saver is not activated. (Outputs the interior room lamp power supply)		12 V	E
5 (P)	Ground	Passenger door UN- LOCK	Output	Passenger door	UNLOCK (Actuator is activated)	12 V	F
					Other than UNLOCK) Ac- tuator is not activated	0 V	
7 (SB)	Ground	Step lamp	Output	Step lamp	ON	0 V	G
					OFF	12 V	
8 (V)	Ground	All doors, fuel lid LOCK	Output	All doors, fuel lid	LOCK (Actuator is activated)	12 V	H
					Other than LOCK (Actuator is not activated)	0 V	
9 (G)	Ground	Driver door, fuel lid UNLOCK	Output	Driver door, fuel lid	UNLOCK (Actuator is activated)	12 V	I
					Other than UNLOCK (Actuator is not activated)	0 V	J
10 (P)	Ground	Rear RH door and rear LH door UN- LOCK	Output	Rear RH door and rear LH door	UNLOCK (Actuator is activated)	12 V	SEC
					Other than UNLOCK (Actuator is not activated)	0 V	
11 (R)	Ground	Battery power supply	Input	Ignition switch OFF		Battery voltage	L
13 (B)	Ground	Ground	—	Ignition switch ON		0 V	M
14*1 (W)	Ground	—	—	—		—	
15 (BG)	Ground	ACC indicator lamp	Output	Ignition switch	OFF (LOCK indicator is not illuminated)	Battery voltage	N
					ACC	0 V	
17 (W)	Ground	Turn signal RH (Front)	Output	Ignition switch ON	Turn signal switch OFF	0 V	O
					Turn signal switch RH		

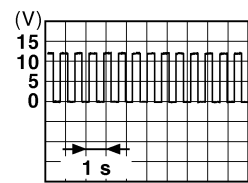

6.5 V

BCM

< ECU DIAGNOSIS INFORMATION >

Terminal No. (Wire color)		Description		Condition	Value (Approx.)
+	-	Signal name	Input/ Output		
18 (BG)	Ground	Turn signal LH (Front)	Output	Ignition switch ON	0 V
				Turn signal switch OFF	6.5 V
19 (V)	Ground	Interior room lamp control	Output	Interior room lamp	12 V
				OFF	0 V
20 (V)	Ground	Turn signal RH (Rear)	Output	Ignition switch ON	0 V
				Turn signal switch OFF	6.5 V
23 (LG)	Ground	Trunk lid open	Output	Trunk lid	12 V
				OPEN (Trunk lid opener actuator is activated)	0 V
25 (Y)	Ground	Turn signal LH (Rear)	Output	Ignition switch ON	0 V
				Turn signal switch OFF	6.5 V
30 (P)	Ground	Trunk room lamp	Output	Trunk room lamp	0 V
				ON	12 V
20 (V)	Ground	Turn signal RH (Rear)	Output	Ignition switch ON	0 V
				Turn signal switch OFF	6.5 V

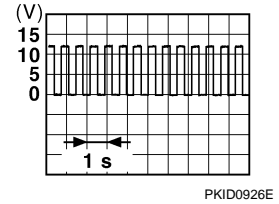
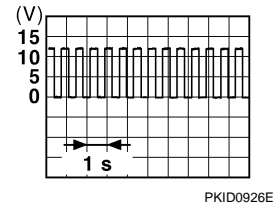
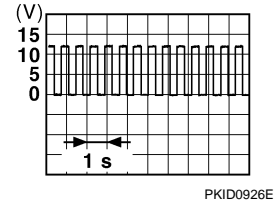

BCM

< ECU DIAGNOSIS INFORMATION >

Terminal No. (Wire color)		Description		Condition	Value (Approx.)
+	-	Signal name	Input/ Output		
34 (SB)	Ground	Trunk room antenna (-)	Output	Ignition switch OFF	
				When Intelligent Key is not in the passenger compart- ment	
35 (V)	Ground	Trunk room antenna (+)	Output	Ignition switch OFF	
				When Intelligent Key is not in the passenger compart- ment	
38 (B)	Ground	Rear bumper anten- na (-)	Output	When the trunk lid opener re- quest switch is operated with ignition switch OFF	
				When Intelligent Key is not in the antenna detection area	

A
B
C
D
E
F
G
H
I
J
L
M
N
O
P

SEC

BCM

< ECU DIAGNOSIS INFORMATION >

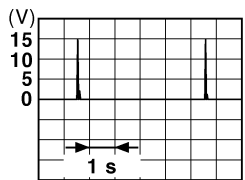
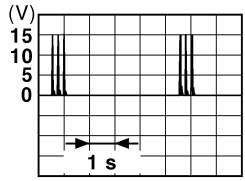
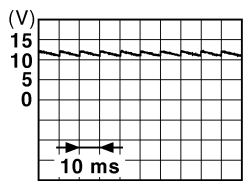
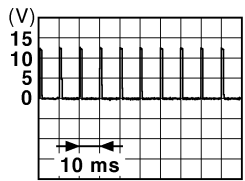
Terminal No. (Wire color)		Description		Condition	Value (Approx.)	
+	-	Signal name	Input/ Output			
39 (W)	Ground	Rear bumper antenna (+)	Output	When the trunk lid opener request switch is operated with ignition switch OFF	 <p style="text-align: right; font-size: small;">JMkia0062GB</p>	
				When Intelligent Key is in the antenna detection area	 <p style="text-align: right; font-size: small;">JMkia0063GB</p>	
47 (Y)	Ground	Ignition relay (IPDM E/R) control	Output	Ignition switch	OFF or ACC	12 V
					ON	0 V
50 (BG)	Ground	Trunk room lamp switch	Input	Trunk room lamp switch	OFF (Trunk lid is closed)	 <p style="text-align: right; font-size: small;">JPMIA0011GB</p>
					ON (Trunk lid is opened)	0 V
52 (R)	Ground	Starter relay control	Output	Ignition switch ON (A/T models)	When selector lever is in P or N position	12 V
					When selector lever is not in P or N position	0 V
				Ignition switch ON (M/T models)	When the clutch pedal is depressed	Battery voltage
					When the clutch pedal is not depressed	0 V
60 (BR)	Ground	Push-button ignition switch (Push switch)	Input	Push-button ignition switch (push switch)	Pressed	0 V
					Not pressed	Battery voltage
61 (SB)	Ground	Trunk lid opener request switch	Input	Trunk lid opener request switch	ON (Pressed)	0 V
					OFF (Not pressed)	 <p style="text-align: right; font-size: small;">JPMIA0016GB</p>
64 (G)	Ground	Intelligent Key warning buzzer (Engine room)	Output	Intelligent Key warning buzzer (Engine room)	Sounding	0 V
					Not sounding	12 V

BCM

< ECU DIAGNOSIS INFORMATION >

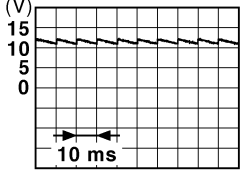
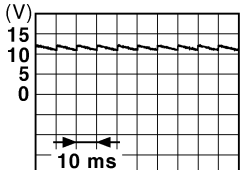
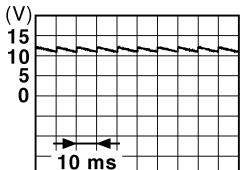
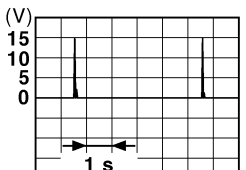
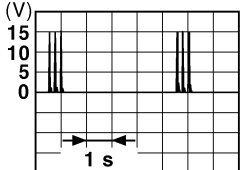
Terminal No. (Wire color)		Description		Condition	Value (Approx.)	
+	-	Signal name	Input/ Output			
67 (GR)	Ground	Trunk lid opener switch	Input	Trunk lid opener switch	Pressed	0 V
					Not pressed	 <p style="text-align: right; font-size: small;">JPMA0011GB</p>
68 (BG)	Ground	Rear RH door switch	Input	Rear RH door switch	OFF (When rear RH door closes)	 <p style="text-align: right; font-size: small;">JPMA0011GB</p>
					ON (When rear RH door opens)	0 V
69 (L)	Ground	Rear LH door switch	Input	Rear LH door switch	OFF (When rear LH door closes)	 <p style="text-align: right; font-size: small;">JPMA0011GB</p>
					ON (When rear LH door opens)	0 V
72 (R)	Ground	Room antenna 2 (-) (Center console)	Output	Ignition switch OFF	When Intelligent Key is in the passenger compartment	 <p style="text-align: right; font-size: small;">JMKIA0062GB</p>
					When Intelligent Key is not in the passenger compartment	 <p style="text-align: right; font-size: small;">JMKIA0063GB</p>

A
B
C
D
E
F
G
H
I
J
L
M
N
O
P

SEC

BCM

< ECU DIAGNOSIS INFORMATION >

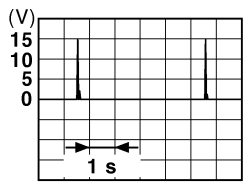
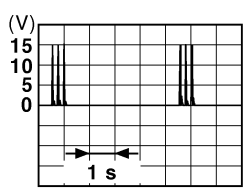
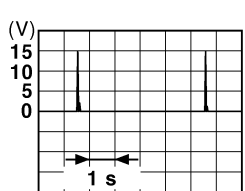
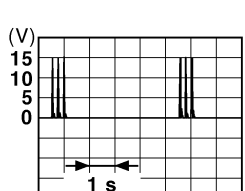
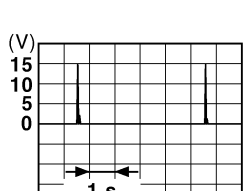
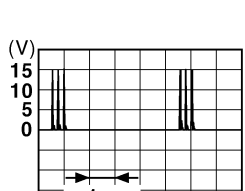
Terminal No. (Wire color)		Description		Condition	Value (Approx.)
+	-	Signal name	Input/ Output		
73 (G)	Ground	Room antenna 2 (+) (Center console)	Output	Ignition switch OFF	<p>When Intelligent Key is in the passenger compartment</p>  <p style="text-align: right; font-size: small;">JMKIA0062GB</p>
					<p>When Intelligent Key is not in the passenger compartment</p>  <p style="text-align: right; font-size: small;">JMKIA0063GB</p>
74 (SB)	Ground	Passenger door antenna (-)	Output	When the passenger door request switch is operated with ignition switch OFF	<p>When Intelligent Key is in the antenna detection area</p>  <p style="text-align: right; font-size: small;">JMKIA0062GB</p>
					<p>When Intelligent Key is not in the antenna detection area</p>  <p style="text-align: right; font-size: small;">JMKIA0063GB</p>
75 (BR)	Ground	Passenger door antenna (+)	Output	When the passenger door request switch is operated with ignition switch OFF	<p>When Intelligent Key is in the antenna detection area</p>  <p style="text-align: right; font-size: small;">JMKIA0062GB</p>
					<p>When Intelligent Key is not in the antenna detection area</p>  <p style="text-align: right; font-size: small;">JMKIA0063GB</p>

BCM

< ECU DIAGNOSIS INFORMATION >

Terminal No. (Wire color)		Description		Condition	Value (Approx.)
+	-	Signal name	Input/ Output		
76 (V)	Ground	Driver door antenna (-)	Output	When the driver door request switch is operated with ignition switch OFF	<p style="text-align: right; font-size: small;">JMkia0062GB</p>
				When Intelligent Key is not in the antenna detection area	<p style="text-align: right; font-size: small;">JMkia0063GB</p>
77 (LG)	Ground	Driver door antenna (+)	Output	When the driver door request switch is operated with ignition switch OFF	<p style="text-align: right; font-size: small;">JMkia0062GB</p>
				When Intelligent Key is not in the antenna detection area	<p style="text-align: right; font-size: small;">JMkia0063GB</p>
78 (Y)	Ground	Room antenna 1 (-) (Instrument panel)	Output	Ignition switch OFF	<p style="text-align: right; font-size: small;">JMkia0062GB</p>
				When Intelligent Key is not in the passenger compartment	<p style="text-align: right; font-size: small;">JMkia0063GB</p>

A
B
C
D
E
F
G
H
I
J
L
M
N
O
P

SEC

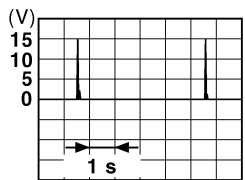
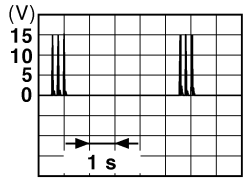
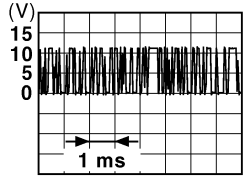
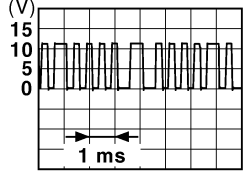

BCM

< ECU DIAGNOSIS INFORMATION >

Terminal No. (Wire color)		Description		Condition	Value (Approx.)	
+	-	Signal name	Input/ Output			
79 (BR)	Ground	Room antenna 1 (+) (Instrument panel)	Output	Ignition switch OFF	 <p style="text-align: right; font-size: small;">JMkia0062GB</p>	
				When Intelligent Key is not in the passenger compart- ment	 <p style="text-align: right; font-size: small;">JMkia0063GB</p>	
80 (GR)	Ground	NATS antenna amp.	Input/ Output	During waiting	Ignition switch is pressed while inserting the Intelli- gent Key into the key slot.	Just after pressing ignition switch. Pointer of tester should move.
81 (W)	Ground	NATS antenna amp.	Input/ Output	During waiting	Ignition switch is pressed while inserting the Intelli- gent Key into the key slot.	Just after pressing ignition switch. Pointer of tester should move.
82 (SB)	Ground	Ignition relay [Fuse block (J/B)] control	Output	Ignition switch	OFF or ACC	0 V
					ON	12 V
83 (Y)	Ground	Remote keyless entry receiver communica- tion	Input/ Output	During waiting		 <p style="text-align: right; font-size: small;">JMkia0064GB</p>
				When operating either button on the Intelli- gent Key		 <p style="text-align: right; font-size: small;">JMkia0065GB</p>

BCM

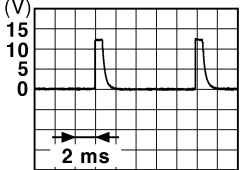
< ECU DIAGNOSIS INFORMATION >

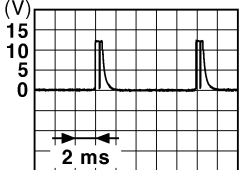

Terminal No. (Wire color)		Description		Condition	Value (Approx.)	
+	-	Signal name	Input/ Output			
87 (Y)	Ground	Combination switch INPUT 5	Input	Combination switch	All switches OFF (Wiper volume dial 4)	 <p style="text-align: right;">JPMA0041GB</p> <p style="text-align: center;">1.4 V</p>
					Front fog lamp switch ON (Wiper volume dial 4)	 <p style="text-align: right;">JPMA0037GB</p> <p style="text-align: center;">1.3 V</p>
					Any of the conditions below with all switches OFF <ul style="list-style-type: none"> • Wiper volume dial 1 • Wiper volume dial 2 • Wiper volume dial 6 • Wiper volume dial 7 	 <p style="text-align: right;">JPMA0040GB</p> <p style="text-align: center;">1.3 V</p>

A
B
C
D
E
F
G
H
I
J

SEC

BCM

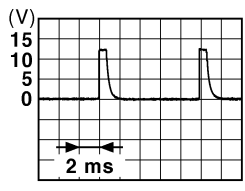
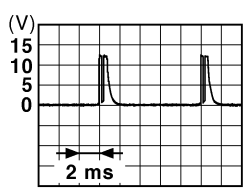
< ECU DIAGNOSIS INFORMATION >

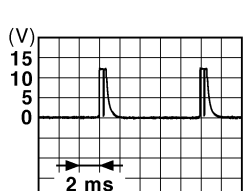
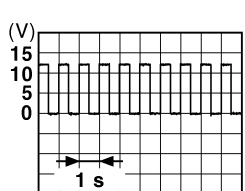
Terminal No. (Wire color)		Description		Condition	Value (Approx.)	
+	-	Signal name	Input/ Output			
88 (BG)	Ground	Combination switch INPUT 3	Input	Combination switch	All switches OFF (Wiper volume dial 4)	 <p style="text-align: right; font-size: small;">JPMA0041GB</p> <p style="text-align: center;">1.4 V</p>
					Lighting switch HI (Wiper volume dial 4)	 <p style="text-align: right; font-size: small;">JPMA0036GB</p> <p style="text-align: center;">1.3 V</p>
					Lighting switch 2ND (Wiper volume dial 4)	 <p style="text-align: right; font-size: small;">JPMA0037GB</p> <p style="text-align: center;">1.3 V</p>
					Any of the conditions below with all switches OFF <ul style="list-style-type: none"> • Wiper volume dial 1 • Wiper volume dial 2 • Wiper volume dial 3 	 <p style="text-align: right; font-size: small;">JPMA0040GB</p> <p style="text-align: center;">1.3 V</p>
90 (P)	Ground	CAN-L	Input/ Output	—	—	
91 (L)	Ground	CAN-H	Input/ Output	—	—	
92 (LG)	Ground	Key slot illumination	Output	Key slot illumi- nation	OFF	12 V
					Blinking	 <p style="text-align: right; font-size: small;">JPMA0015GB</p> <p style="text-align: center;">6.5 V</p>
93 (GR)	Ground	ON indicator lamp	Output	Ignition switch	OFF (LOCK indicator is not illuminated)	Battery voltage
					ON	0 V

BCM

< ECU DIAGNOSIS INFORMATION >

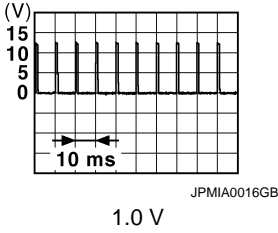
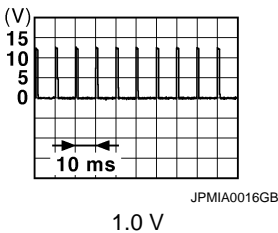

Terminal No. (Wire color)		Description		Condition		Value (Approx.)
+	-	Signal name	Input/ Output			
95 (BG)	Ground	ACC relay control	Output	Ignition switch	OFF	0 V
					ACC or ON	12 V
96 (GR)	Ground	A/T shift selector (Detention switch) power supply	Output	—		12 V
99 (R)* ² (BR)* ³	Ground	Selector lever P position switch (A/T models)	Input	Selector lever	P position	0 V
					Any position other than P	12 V
		ASCD clutch switch (M/T models without ICC)		ASCD clutch switch	OFF (Clutch pedal is depressed)	0 V
					ON (Clutch pedal is not depressed)	12 V
		ICC clutch switch (M/T models with ICC)		ICC clutch switch	OFF (Clutch pedal is depressed)	0 V
					ON (Clutch pedal is not depressed)	12 V
100 (Y)	Ground	Passenger door request switch	Input	Passenger door request switch	ON (Pressed)	0 V
					OFF (Not pressed)	
101 (P)	Ground	Driver door request switch	Input	Driver door request switch	ON (Pressed)	0 V
					OFF (Not pressed)	
102 (BG)	Ground	Blower fan motor relay control	Output	Ignition switch	OFF or ACC	0 V
					ON	12 V
103 (P)	Ground	Remote keyless entry receiver power supply	Output	Ignition switch OFF		12 V

A
B
C
D
E
F
G
H
I
J
L
M
N
O
P

SEC

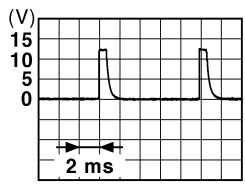
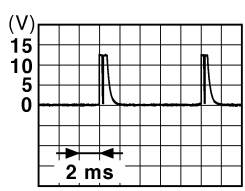

BCM

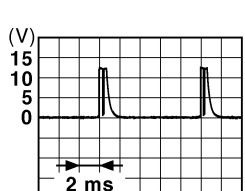
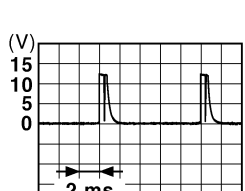
< ECU DIAGNOSIS INFORMATION >

Terminal No. (Wire color)		Description		Condition	Value (Approx.)	
+	-	Signal name	Input/ Output			
107 (LG)	Ground	Combination switch INPUT 1	Input	Combination switch (Wiper volume dial 4)	All switches OFF	 <p style="text-align: center;">1.4 V</p>
					Turn signal switch LH	 <p style="text-align: center;">1.3 V</p>
					Turn signal switch RH	 <p style="text-align: center;">1.3 V</p>
					Front wiper switch LO	 <p style="text-align: center;">1.3 V</p>
					Front washer switch ON	 <p style="text-align: center;">1.3 V</p>

BCM

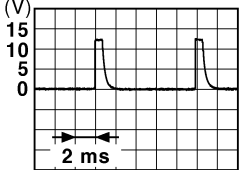
< ECU DIAGNOSIS INFORMATION >

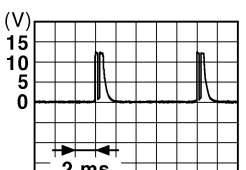
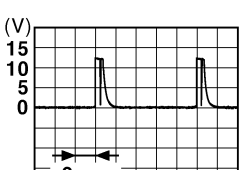



Terminal No. (Wire color)		Description		Condition	Value (Approx.)	
		Signal name	Input/ Output			
+	-					
108 (R)	Ground	Combination switch INPUT 4	Input	Combination switch	All switches OFF (Wiper volume dial 4)	 <p style="text-align: right; font-size: small;">JPMIA0041GB</p> <p style="text-align: center;">1.4 V</p>
					Lighting switch AUTO (Wiper volume dial 4)	 <p style="text-align: right; font-size: small;">JPMIA0038GB</p> <p style="text-align: center;">1.3 V</p>
					Lighting switch 1ST (Wiper volume dial 4)	 <p style="text-align: right; font-size: small;">JPMIA0036GB</p> <p style="text-align: center;">1.3 V</p>
					Any of the conditions below with all switches OFF <ul style="list-style-type: none"> • Wiper volume dial 1 • Wiper volume dial 5 • Wiper volume dial 6 	 <p style="text-align: right; font-size: small;">JPMIA0039GB</p> <p style="text-align: center;">1.3 V</p>

A
B
C
D
E
F
G
H
I
J
L
M
N
O
P

SEC

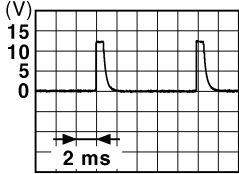
BCM

< ECU DIAGNOSIS INFORMATION >

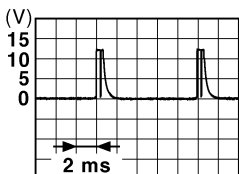
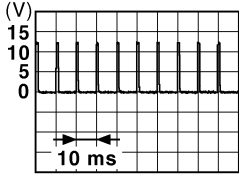
Terminal No. (Wire color)		Description		Condition	Value (Approx.)	
+	-	Signal name	Input/ Output			
109 (W)	Ground	Combination switch INPUT 2	Input	Combination switch (Wiper volume dial 4)	All switches OFF	 <p style="text-align: right; font-size: small;">JPMA0041GB</p> <p style="text-align: center;">1.4 V</p>
					Lighting switch PASS	 <p style="text-align: right; font-size: small;">JPMA0037GB</p> <p style="text-align: center;">1.3 V</p>
					Lighting switch 2ND	 <p style="text-align: right; font-size: small;">JPMA0036GB</p> <p style="text-align: center;">1.3 V</p>
					Front wiper switch INT/ AUTO	 <p style="text-align: right; font-size: small;">JPMA0038GB</p> <p style="text-align: center;">1.3 V</p>
					Front wiper switch HI	 <p style="text-align: right; font-size: small;">JPMA0040GB</p> <p style="text-align: center;">1.3 V</p>
110 (G)	Ground	Hazard switch	Input	Hazard switch	ON	0 V
					OFF	 <p style="text-align: right; font-size: small;">JPMA0012GB</p> <p style="text-align: center;">1.1 V</p>

BCM

< ECU DIAGNOSIS INFORMATION >

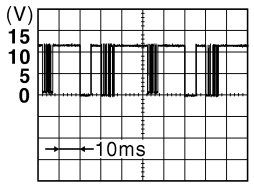
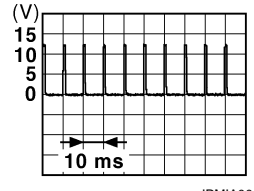
Terminal No. (Wire color)		Description		Condition	Value (Approx.)
+	-	Signal name	Input/ Output		
112 (R)	Ground	Rain sensor serial link	Input/ Output	Ignition switch ON	 <p style="text-align: center;">8.7 V</p>
113 (BG)	Ground	Optical sensor	Input	Ignition switch ON	When bright outside of the vehicle Close to 5 V
				Ignition switch ON	When dark outside of the vehicle Close to 0 V
114 (R)	Ground	Clutch interlock switch	Input	Clutch interlock switch	OFF (Clutch pedal is not depressed) 0 V
				Clutch interlock switch	ON (Clutch pedal is depressed) Battery voltage
116 (SB)	Ground	Stop lamp switch 1	Input	—	Battery voltage
118 (BR)	Ground	Stop lamp switch 2 (Without ICC)	Input	Stop lamp switch	OFF (Brake pedal is not depressed) 0 V
				Stop lamp switch	ON (Brake pedal is depressed) Battery voltage
		Stop lamp switch 2 (With ICC)		Stop lamp switch OFF (Brake pedal is not depressed) and ICC brake hold relay OFF 0 V	
				Stop lamp switch ON (Brake pedal is depressed) or ICC brake hold relay ON Battery voltage	
119 (SB)	Ground	Front door lock assembly driver side (Unlock sensor)	Input	Driver door	 <p style="text-align: center;">1.1 V</p>
				Driver door	UNLOCK status (Unlock switch sensor ON) 0 V
121 (SB)	Ground	Key slot switch	Input	When the Intelligent Key is inserted into key slot 12 V	
				When the Intelligent Key is not inserted into key slot 0 V	
123 (V)	Ground	IGN feedback	Input	Ignition switch	OFF or ACC 0 V
				Ignition switch	ON Battery voltage

A
B
C
D
E
F
G
H
I
J
L
M
N
O
P

SEC

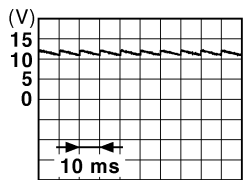
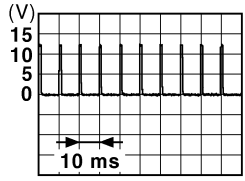
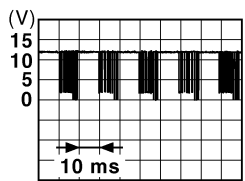

BCM

< ECU DIAGNOSIS INFORMATION >

Terminal No. (Wire color)		Description		Condition		Value (Approx.)
+	-	Signal name	Input/ Output			
124 (R)	Ground	Passenger door switch	Input	Passenger door switch	OFF (Door close)	 <p style="text-align: right; font-size: small;">JPMA0011GB</p> <p style="text-align: center;">11.8 V</p>
					ON (Door open)	0 V
129 (BG)	Ground	Trunk lid opener cancel switch	Input	Trunk lid open- er cancel switch	CANCEL	 <p style="text-align: right; font-size: small;">JPMA0012GB</p> <p style="text-align: center;">1.1 V</p>
					ON	0 V
132 (V)	Ground	Power window switch communication	Input/ Output	Ignition switch ON		 <p style="text-align: right; font-size: small;">JPMA0013GB</p> <p style="text-align: center;">10.2 V</p>
					Ignition switch OFF or ACC	12 V
133 (L)	Ground	Push-button ignition switch illumination	Output	Push-button igni- tion switch il- lumination	ON (Tail lamps OFF)	9.5 V
					OFF	0 V
134 (LG)	Ground	LOCK indicator lamp	Output	LOCK indicator lamp	OFF	Battery voltage
					ON	0 V
137 (BG)	Ground	Receiver and sensor ground	Input	Ignition switch ON		0 V
138 (V)	Ground	Receiver and sensor power supply	Output	Ignition switch	OFF	0 V
					ACC or ON	5.0 V

BCM

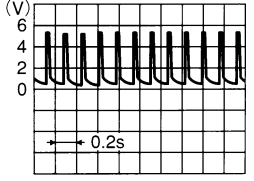
< ECU DIAGNOSIS INFORMATION >

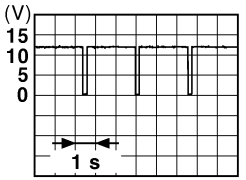
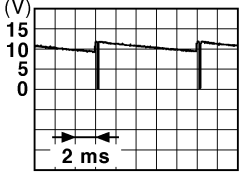
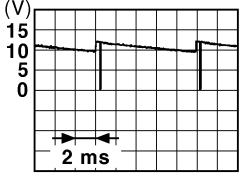
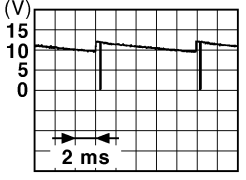
Terminal No. (Wire color)		Description		Condition	Value (Approx.)
+	-	Signal name	Input/ Output		
139 (L)	Ground	Tire pressure receiver communication	Input/ Output	Ignition switch ON	Standby state  OCC3881D
				When receiving the signal from the transmitter  OCC3880D	
140 (B)	Ground	Selector lever P/N position	Input	Selector lever	P or N position 12 V Except P and N positions 0 V
				ON	0 V
141 (W)	Ground	Security indicator lamp	Output	Security indicator lamp	Blinking  JPMIA0014GB 11.3 V
				OFF	12 V
142 (BR)	Ground	Combination switch OUTPUT 5	Output	Combination switch (Wiper volume dial 4)	All switches OFF 0 V Lighting switch 1ST Lighting switch HI Lighting switch 2ND Turn signal switch RH  JPMIA0031GB 10.7 V
				Combination switch	All switches OFF (Wiper volume dial 4) 0 V
				Combination switch	Front wiper switch HI (Wiper volume dial 4) Any of the conditions below with all switches OFF • Wiper volume dial 1 • Wiper volume dial 2 • Wiper volume dial 3 • Wiper volume dial 6 • Wiper volume dial 7  JPMIA0032GB 10.7 V
				Combination switch	
143 (P)	Ground	Combination switch OUTPUT 1	Output	Combination switch	All switches OFF (Wiper volume dial 4) 0 V
				Combination switch	Front wiper switch HI (Wiper volume dial 4) Any of the conditions below with all switches OFF • Wiper volume dial 1 • Wiper volume dial 2 • Wiper volume dial 3 • Wiper volume dial 6 • Wiper volume dial 7  JPMIA0032GB 10.7 V

A
B
C
D
E
F
G
H
I
J
L
M
N
O
P

SEC

BCM

< ECU DIAGNOSIS INFORMATION >

Terminal No. (Wire color)		Description		Condition	Value (Approx.)	
+	-	Signal name	Input/ Output			
144 (G)	Ground	Combination switch OUTPUT 2	Output	Combination switch	All switches OFF (Wiper volume dial 4)	0 V
					Front washer switch ON (Wiper volume dial 4)	<p style="text-align: right; font-size: small;">JPMIA0033GB</p>
					Any of the conditions below with all switches OFF	
					<ul style="list-style-type: none"> • Wiper volume dial 1 • Wiper volume dial 5 • Wiper volume dial 6 	
145 (L)	Ground	Combination switch OUTPUT 3	Output	Combination switch (Wiper volume dial 4)	All switches OFF	0 V
					Front wiper switch INT/ AUTO	<p style="text-align: right; font-size: small;">JPMIA0034GB</p>
					Front wiper switch LO	
					Lighting switch AUTO	10.7 V
146 (SB)	Ground	Combination switch OUTPUT 4	Output	Combination switch (Wiper volume dial 4)	All switches OFF	0 V
					Front fog lamp switch ON	<p style="text-align: right; font-size: small;">JPMIA0035GB</p>
					Lighting switch 2ND	
					Lighting switch PASS	
					Turn signal switch LH	10.7 V
150 (GR)	Ground	Driver door switch	Input	Driver door switch	OFF (Door close)	<p style="text-align: right; font-size: small;">JPMIA0011GB</p>
					ON (Door open)	0 V
151 (G)	Ground	Rear window defogger relay control	Output	Rear window defogger	Active	0 V
				Not activated	Battery voltage	

- *1: This harness is not used.
- *2: A/T models
- *3: M/T models

Wiring Diagram - BCM -

INFOID:000000007753447

For connector terminal arrangements, harness layouts, and alphabets in a  (option abbreviation; if not described in wiring diagram), refer to [GI-12, "Connector Information"](#).

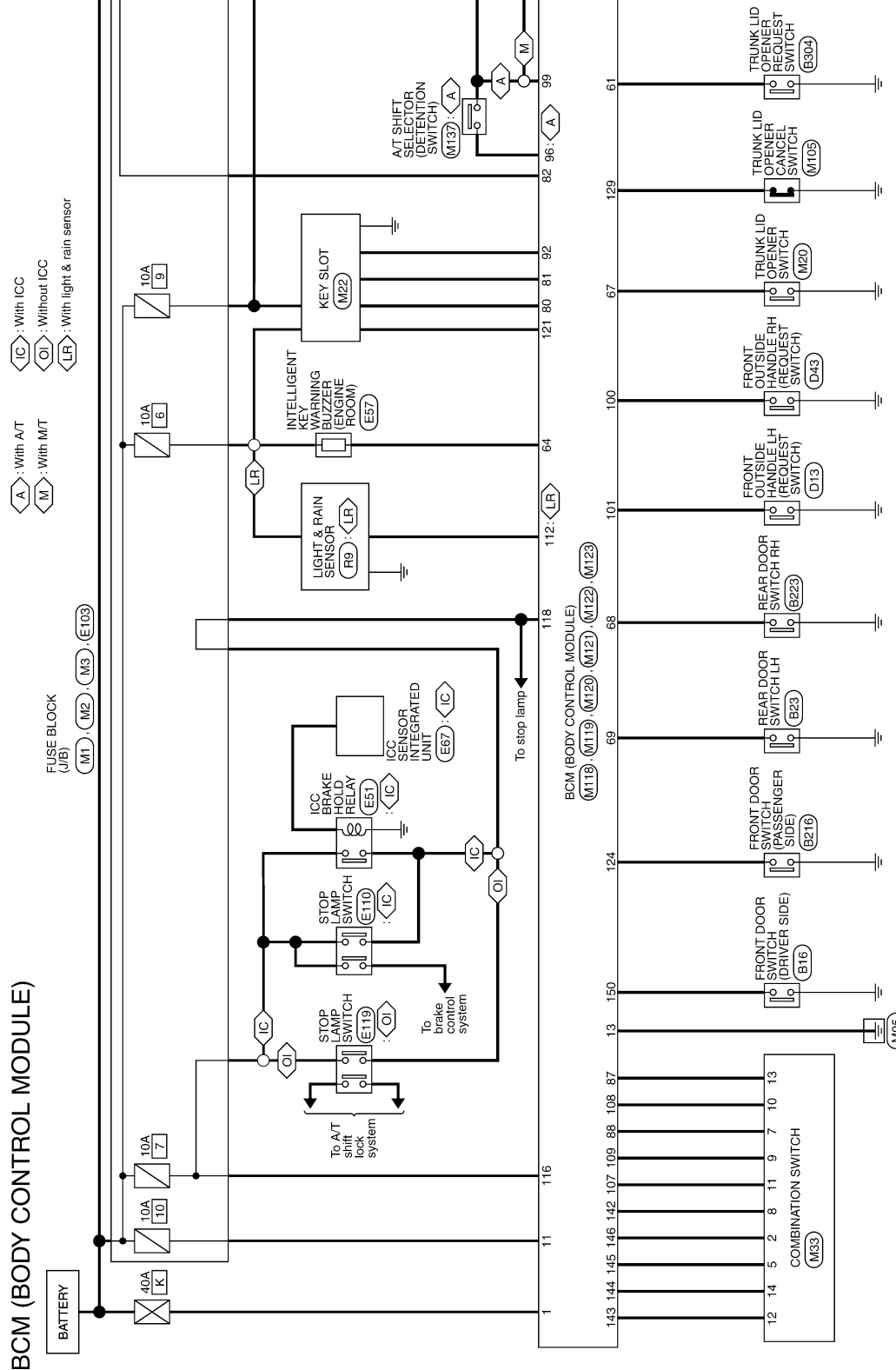

JRMWC4270GB

2011/07/07

A
B
C
D
E
F
G
H
I
J
K
L
M
N
O
P

SEC

◊ A ◊ : With A/T
 ◊ M ◊ : With M/T
 ◊ AL ◊ : With auto light
 ◊ IC ◊ : With ICC
 ◊ OI ◊ : Without ICC

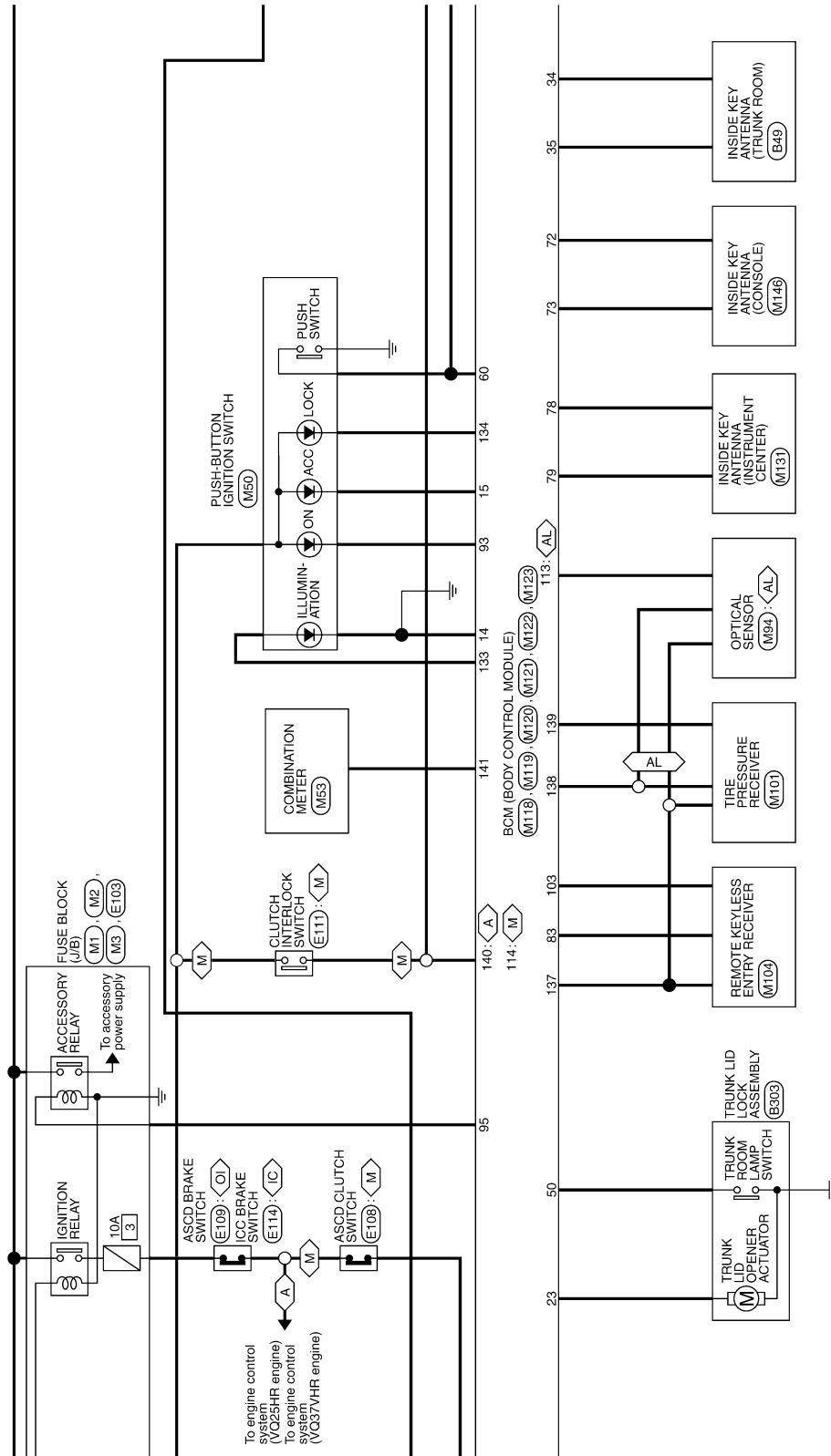

JRMWC4271GB

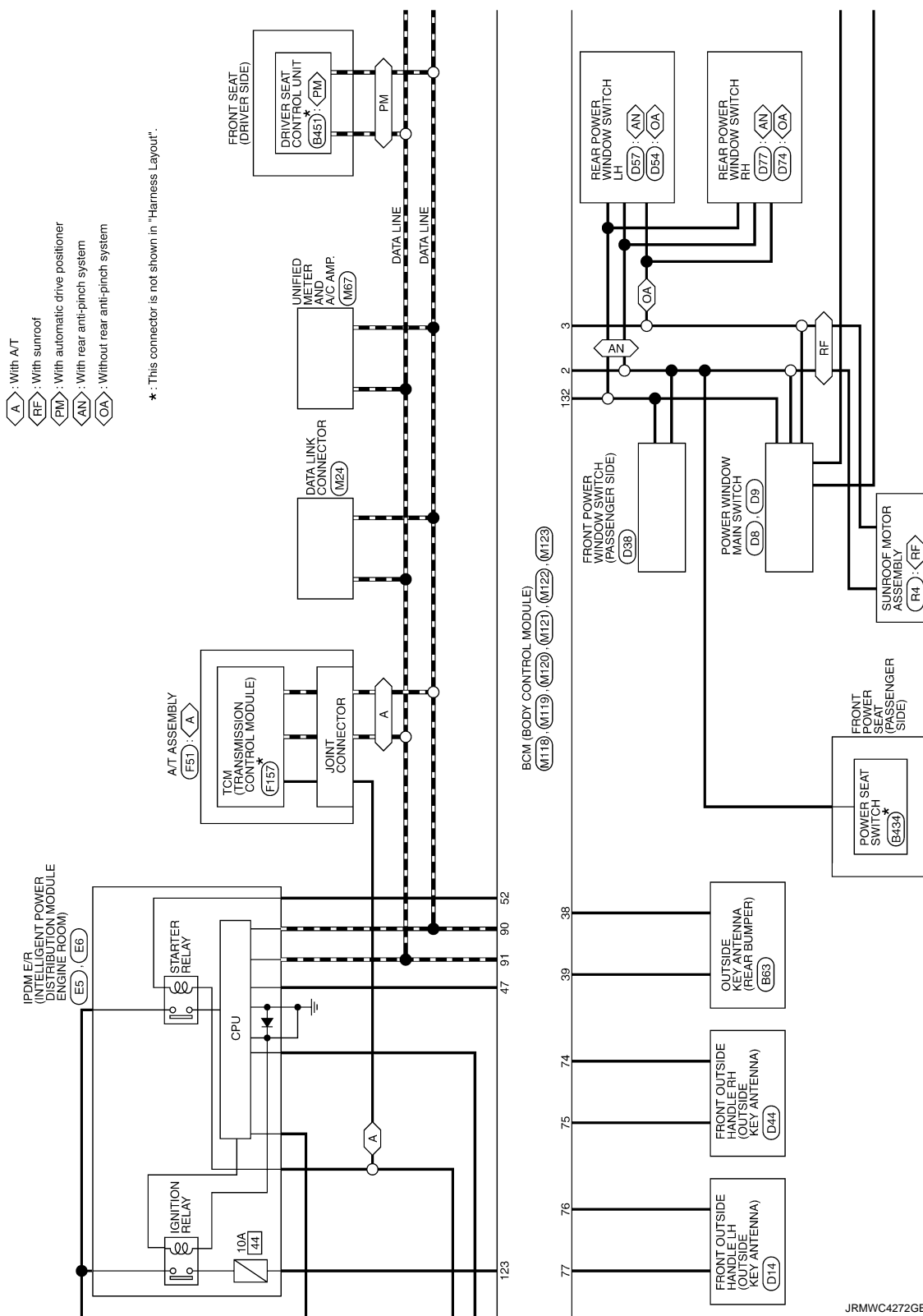

A
B
C
D
E
F
G
H
I
J
L
M
N
O
P

SEC

BCM

< ECU DIAGNOSIS INFORMATION >

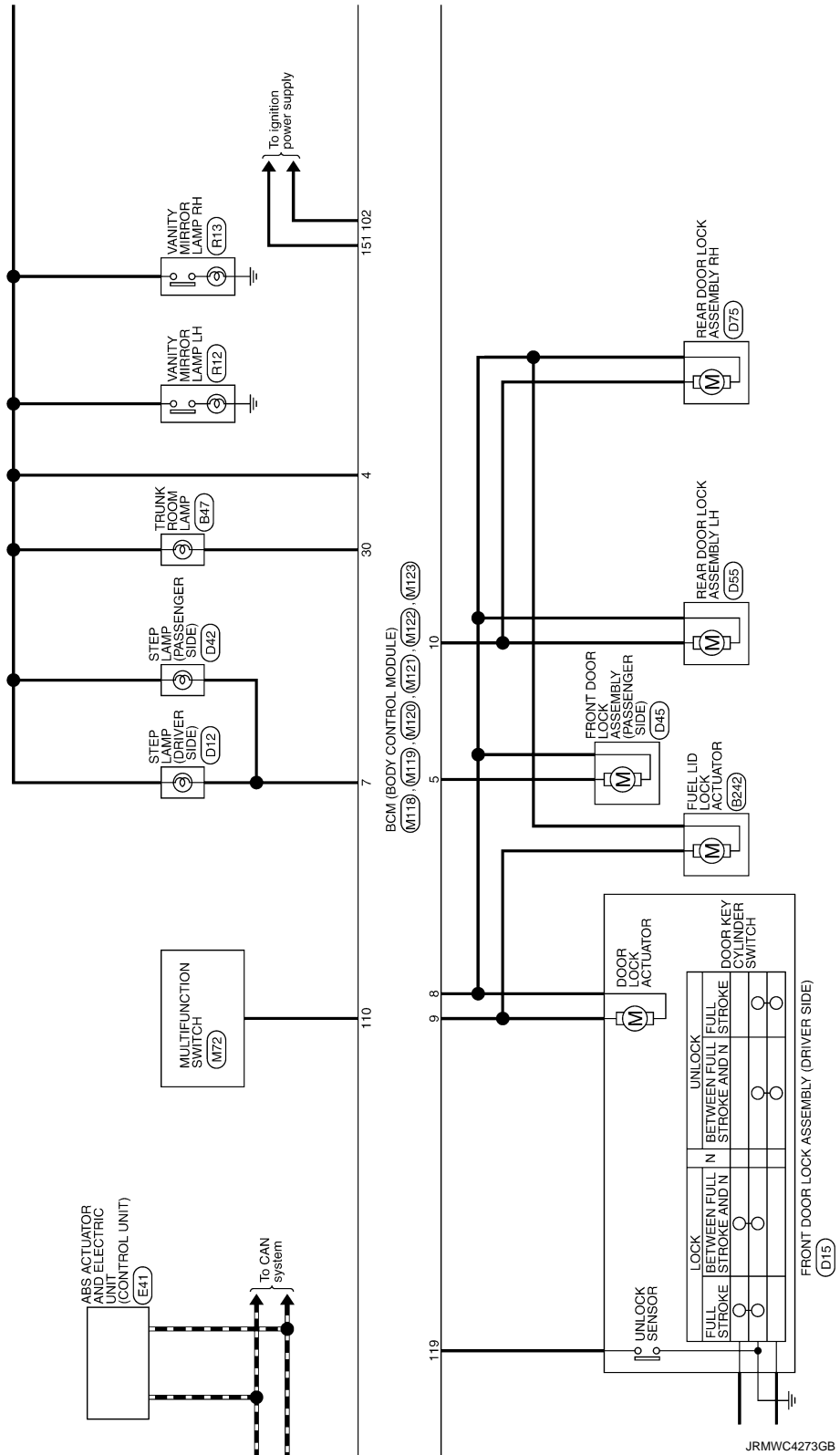

A
B
C
D
E
F
G
H
I
J
L
M
N
O
P

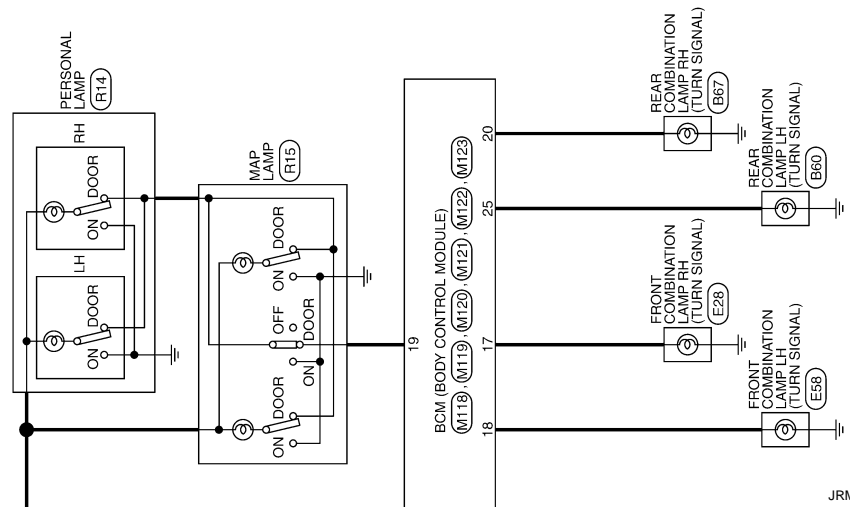

JRMWC4274GB

Fail-safe

FAIL-SAFE CONTROL BY DTC

BCM performs fail-safe control when any DTC are detected.

INFOID:000000007753448

SEC

BCM

< ECU DIAGNOSIS INFORMATION >

Display contents of CONSULT	Fail-safe	Cancellation
B2190: NATS ANTENNA AMP	Inhibit engine cranking	Erase DTC
B2191: DIFFERENCE OF KEY	Inhibit engine cranking	Erase DTC
B2192: ID DISCORD BCM-ECM	Inhibit engine cranking	Erase DTC
B2193: CHAIN OF BCM-ECM	Inhibit engine cranking	Erase DTC
B2195: ANTI-SCANNING	Inhibit engine cranking	Ignition switch ON → OFF
B2560: STARTER CONT RELAY	Inhibit engine cranking	500 ms after the following CAN signal communication status becomes consistent <ul style="list-style-type: none"> • Starter control relay signal • Starter relay status signal
B2608: STARTER RELAY	Inhibit engine cranking	500 ms after the following signal communication status becomes consistent <ul style="list-style-type: none"> • Starter motor relay control signal • Starter relay status signal (CAN)
B260A: IGNITION RELAY	Inhibit engine cranking	500 ms after the following conditions are fulfilled <ul style="list-style-type: none"> • IGN relay (IPDM E/R) control signal: OFF (12 V) • Ignition ON signal (CAN to IPDM E/R): OFF (Request signal) • Ignition ON signal (CAN from IPDM E/R): OFF (Condition signal)
B260F: ENG STATE SIG LOST	Maintains the power supply position attained at the time of DTC detection	When any of the following conditions are fulfilled <ul style="list-style-type: none"> • Power position changes to ACC • Receives engine status signal (CAN)
B2617: BCM	Inhibit engine cranking	1 second after the starter motor relay control inside BCM becomes normal
B2618: BCM	Inhibit engine cranking	1 second after the ignition relay (IPDM E/R) control inside BCM becomes normal
B261E: VEHICLE TYPE	Inhibit engine cranking	BCM initialization
B26E8: CLUTCH SW	Inhibit engine cranking	When any of the following BCM recognition conditions are fulfilled <ul style="list-style-type: none"> • Status 1 <ul style="list-style-type: none"> - Clutch switch signal (CAN from ECM): ON - Clutch interlock switch signal: OFF (0 V) • Status 2 <ul style="list-style-type: none"> - Clutch switch signal (CAN from ECM): OFF - Clutch interlock switch signal: ON (Battery voltage)

DTC Inspection Priority Chart

INFOID:000000007753449

If some DTCs are displayed at the same time, perform inspections one by one based on the following priority chart.

Priority	DTC
1	B2562: LOW VOLTAGE
2	<ul style="list-style-type: none"> • U1000: CAN COMM • U1010: CONTROL UNIT(CAN)
3	<ul style="list-style-type: none"> • B2190: NATS ANTENNA AMP • B2191: DIFFERENCE OF KEY • B2192: ID DISCORD BCM-ECM • B2193: CHAIN OF BCM-ECM • B2195: ANTI-SCANNING

BCM

< ECU DIAGNOSIS INFORMATION >

Priority	DTC		
4	<ul style="list-style-type: none"> • B2553: IGNITION RELAY • B2555: STOP LAMP • B2556: PUSH-BTN IGN SW • B2557: VEHICLE SPEED • B2560: STARTER CONT RELAY • B2601: SHIFT POSITION • B2602: SHIFT POSITION • B2603: SHIFT POSI STATUS • B2604: PNP/CLUTCH SW • B2605: PNP/CLUTCH SW • B2608: STARTER RELAY • B260A: IGNITION RELAY • B260F: ENG STATE SIG LOST • B2614: BCM • B2615: BCM • B2616: BCM • B2617: BCM • B2618: BCM • B261A: PUSH-BTN IGN SW • B261E: VEHICLE TYPE • B26E8: CLUTCH SW • B26EA: KEY REGISTRATION • C1729: VHCL SPEED SIG ERR • U0415: VEHICLE SPEED 	A B C D E F G	
	<ul style="list-style-type: none"> • C1704: LOW PRESSURE FL • C1705: LOW PRESSURE FR • C1706: LOW PRESSURE RR • C1707: LOW PRESSURE RL • C1708: [NO DATA] FL • C1709: [NO DATA] FR • C1710: [NO DATA] RR • C1711: [NO DATA] RL • C1716: [PRESSDATA ERR] FL • C1717: [PRESSDATA ERR] FR • C1718: [PRESSDATA ERR] RR • C1719: [PRESSDATA ERR] RL • C1734: CONTROL UNIT 	H I J	
	6	<ul style="list-style-type: none"> • B2621: INSIDE ANTENNA • B2622: INSIDE ANTENNA • B2623: INSIDE ANTENNA 	L M N

SEC

DTC Index

INFOID:000000007753450

NOTE:

The details of time display are as follows.

- CRNT: A malfunction is detected now.
- PAST: A malfunction was detected in the past.

IGN counter is displayed on Freeze Frame Data. For details of Freeze Frame Data, refer to [BCS-16. "COMMON ITEM : CONSULT Function \(BCM - COMMON ITEM\)"](#).

CONSULT display	Fail-safe	Freeze Frame Data •Vehicle Speed •Odo/Trip Meter •Vehicle condition	Intelligent Key warning lamp ON	Tire pressure monitor warning lamp ON	Refer- ence page
No DTC is detected. further testing may be required.	—	—	—	—	—
U1000: CAN COMM	—	—	—	—	BCS-35
U1010: CONTROL UNIT(CAN)	—	—	—	—	BCS-36
U0415: VEHICLE SPEED	—	—	—	—	BCS-37
B2190: NATS ANTENNA AMP	×	—	—	—	SEC-44

BCM

< ECU DIAGNOSIS INFORMATION >

CONSULT display	Fail-safe	Freeze Frame Data •Vehicle Speed •Odo/Trip Meter •Vehicle condition	Intelligent Key warning lamp ON	Tire pressure monitor warning lamp ON	Refer- ence page
B2191: DIFFERENCE OF KEY	×	—	—	—	SEC-47
B2192: ID DISCORD BCM-ECM	×	—	—	—	SEC-48
B2193: CHAIN OF BCM-ECM	×	—	—	—	SEC-50
B2195: ANTI-SCANNING	×	—	—	—	SEC-51
B2553: IGNITION RELAY	—	×	—	—	PCS-48
B2555: STOP LAMP	—	×	—	—	SEC-52
B2556: PUSH-BTN IGN SW	—	×	×	—	SEC-54
B2557: VEHICLE SPEED	×	×	×	—	SEC-56
B2560: STARTER CONT RELAY	×	×	×	—	SEC-57
B2562: LOW VOLTAGE	—	×	—	—	BCS-38
B2601: SHIFT POSITION	×	×	×	—	SEC-58
B2602: SHIFT POSITION	×	×	×	—	SEC-61
B2603: SHIFT POSI STATUS	×	×	×	—	SEC-64
B2604: PNP/CLUTCH SW	×	×	×	—	SEC-67
B2605: PNP/CLUTCH SW	×	×	×	—	SEC-69
B2608: STARTER RELAY	×	×	×	—	SEC-71
B260A: IGNITION RELAY	×	×	×	—	PCS-50
B260F: ENG STATE SIG LOST	×	×	×	—	SEC-73
B2614: BCM	—	×	×	—	PCS-52
B2615: BCM	—	×	×	—	PCS-54
B2616: BCM	—	×	×	—	PCS-56
B2617: BCM	×	×	×	—	SEC-78
B2618: BCM	×	×	×	—	PCS-58
B261A: PUSH-BTN IGN SW	—	×	×	—	PCS-59
B261E: VEHICLE TYPE	×	×	× (Turn ON for 15 seconds)	—	SEC-80
B2621: INSIDE ANTENNA	—	×	—	—	DLK-59
B2622: INSIDE ANTENNA	—	×	—	—	DLK-61
B2623: INSIDE ANTENNA	—	×	—	—	DLK-63
B26E8: CLUTCH SW	×	×	×	—	SEC-75
B26EA: KEY REGISTRATION	—	×	× (Turn ON for 15 seconds)	—	SEC-77
C1704: LOW PRESSURE FL	—	—	—	×	WT-20
C1705: LOW PRESSURE FR	—	—	—	×	
C1706: LOW PRESSURE RR	—	—	—	×	
C1707: LOW PRESSURE RL	—	—	—	×	
C1708: [NO DATA] FL	—	—	—	×	WT-22
C1709: [NO DATA] FR	—	—	—	×	
C1710: [NO DATA] RR	—	—	—	×	
C1711: [NO DATA] RL	—	—	—	×	

BCM

< ECU DIAGNOSIS INFORMATION >

CONSULT display	Fail-safe	Freeze Frame Data •Vehicle Speed •Odo/Trip Meter •Vehicle condition	Intelligent Key warning lamp ON	Tire pressure monitor warning lamp ON	Refer- ence page
C1716: [PRESSDATA ERR] FL	—	—	—	×	WT-25
C1717: [PRESSDATA ERR] FR	—	—	—	×	
C1718: [PRESSDATA ERR] RR	—	—	—	×	
C1719: [PRESSDATA ERR] RL	—	—	—	×	WT-26
C1729: VHCL SPEED SIG ERR	—	—	—	×	
C1734: CONTROL UNIT	—	—	—	×	WT-27

A
B
C
D

E
F
G
H
I
J

SEC

L
M
N
O
P

IPDM E/R

< ECU DIAGNOSIS INFORMATION >

IPDM E/R

Reference Value

INFOID:000000007753453

VALUES ON THE DIAGNOSIS TOOL

Monitor Item	Condition		Value/Status
RAD FAN REQ	Engine idle speed	Changes depending on engine coolant temperature, air conditioner operation status, vehicle speed, etc.	0 - 100 %
AC COMP REQ	Engine running	A/C switch OFF	Off
		A/C switch ON (Compressor is operating)	On
TAIL&CLR REQ	Lighting switch OFF		Off
	Lighting switch 1ST, 2ND, HI or AUTO (Light is illuminated)		On
HL LO REQ	Lighting switch OFF		Off
	Lighting switch 2ND HI or AUTO (Light is illuminated)		On
HL HI REQ	Lighting switch OFF		Off
	Lighting switch HI		On
FR FOG REQ	Lighting switch 2ND or AUTO (Light is illuminated)	Front fog lamp switch OFF	Off
		<ul style="list-style-type: none"> • Front fog lamp switch ON • Daytime running light activated (Only for Canada) 	On
FR WIP REQ	Ignition switch ON	Front wiper switch OFF	Stop
		Front wiper switch INT	1LOW
		Front wiper switch LO	Low
		Front wiper switch HI	Hi
WIP AUTO STOP	Ignition switch ON	Front wiper stop position	STOP P
		Any position other than front wiper stop position	ACT P
WIP PROT	Ignition switch ON	Front wiper operates normally	Off
		Front wiper stops at fail-safe operation	BLOCK
IGN RLY1 -REQ	Ignition switch OFF or ACC		Off
	Ignition switch ON		On
IGN RLY	Ignition switch OFF or ACC		Off
	Ignition switch ON		On
PUSH SW	Release the push-button ignition switch		Off
	Press the push-button ignition switch		On
INTER/NP SW	Ignition switch ON	Selector lever in any position other than P or N (A/T models)	Off
		Release clutch pedal (M/T models)	
	Ignition switch ON	Selector lever in P or N position (A/T models)	On
		Depress clutch pedal (M/T models)	
ST RLY CONT	Ignition switch ON		Off
	At engine cranking		On
IHBT RLY -REQ	Ignition switch ON		Off
	At engine cranking		On

IPDM E/R

< ECU DIAGNOSIS INFORMATION >

Monitor Item	Condition	Value/Status
ST/INHI RLY	Ignition switch ON	Off
	At engine cranking	INHI ON → ST ON
	The status of starter relay or starter control relay cannot be recognized by the battery voltage malfunction, etc. when the starter relay is ON and the starter control relay is OFF	UNKWN
DETENT SW	Ignition switch ON <ul style="list-style-type: none"> • Press the selector button with selector lever in P position • Selector lever in any position other than P 	Off
	Release the selector button with selector lever in P position NOTE: Fixed On for M/T models	On
S/L RLY -REQ	NOTE: The item is indicated, but not monitored.	Off
S/L STATE	NOTE: The item is indicated, but not monitored.	UNLOCK
DTRL REQ	NOTE: The item is indicated, but not monitored.	Off
OIL P SW	Ignition switch OFF, ACC or engine running	Open
	Ignition switch ON	Close
HOOD SW	Close the hood	Off
	Open the hood	On
HL WASHER REQ	NOTE: The item is indicated, but not monitored.	Off
THFT HRN REQ	Not operation	Off
	<ul style="list-style-type: none"> • Panic alarm is activated • Horn is activated with VEHICLE SECURITY (THEFT WARNING) SYSTEM 	On
HORN CHIRP	Not operating	Off
	Door locking with Intelligent Key (horn chirp mode)	On
CRNRNG LMP REQ	NOTE: The item is indicated, but not monitored.	Off

A
B
C
D
E
F
G
H
I
J
L
M
N
O
P

SEC

IPDM E/R

< ECU DIAGNOSIS INFORMATION >

TERMINAL LAYOUT

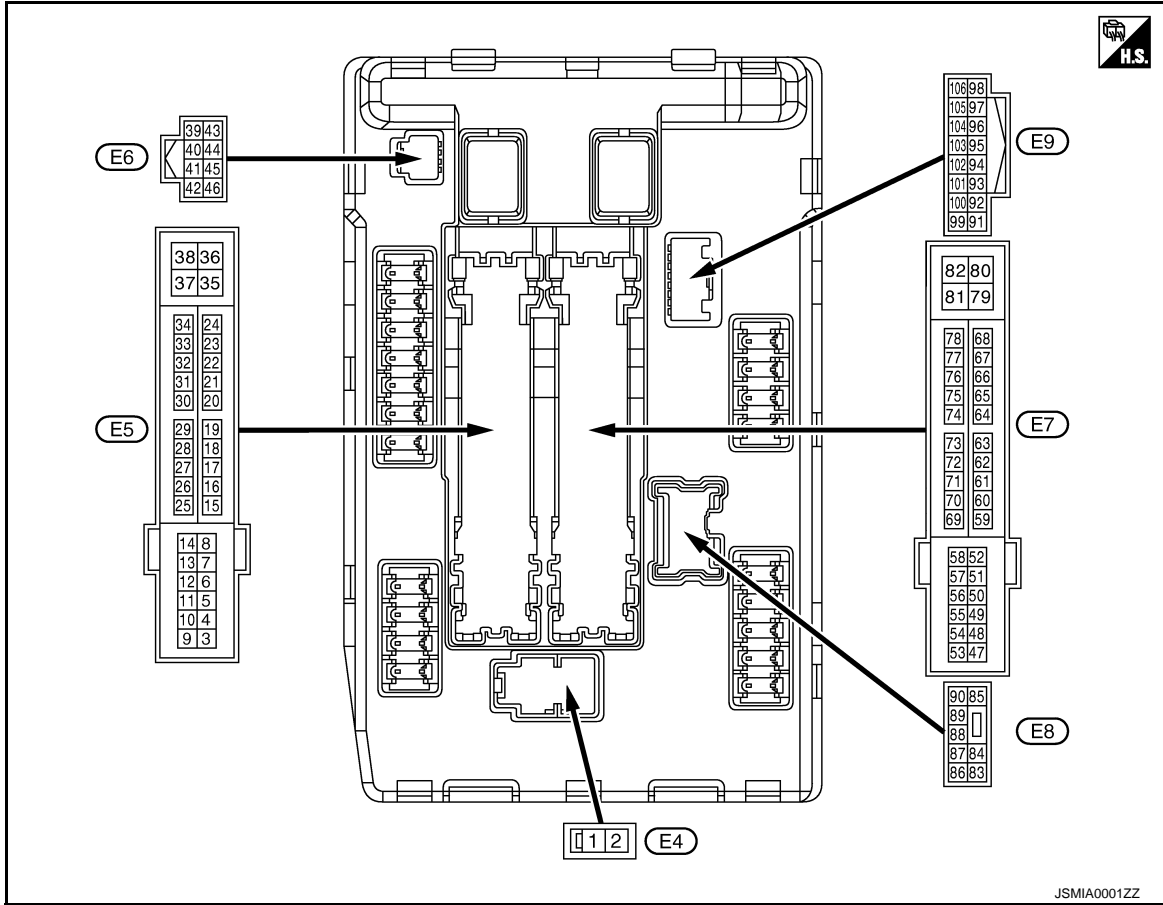

PHYSICAL VALUES

Terminal No. (Wire color)		Description		Condition		Value (Approx.)
+	-	Signal name	Input/ Output			
1 (W)	Ground	Battery power supply	Input	Ignition switch OFF		Battery voltage
2 (L)	Ground	Battery power supply	Input	Ignition switch OFF		Battery voltage
4 (V)	Ground	Front wiper LO	Output	Ignition switch ON	Front wiper switch OFF	0 V
					Front wiper switch LO	Battery voltage
5 (L)	Ground	Front wiper HI	Output	Ignition switch ON	Front wiper switch OFF	0 V
					Front wiper switch HI	Battery voltage
6*4 (SB)	Ground	Daytime running light relay	Input	Ignition switch OFF		Battery voltage
7 (P)	Ground	Tail, license plate lamps & interior lamps	Output	Ignition switch ON	Lighting switch OFF	0 V
					Lighting switch 1ST	Battery voltage
12 (B/W)	Ground	Ground	—	Ignition switch ON		0 V
13 (Y)	Ground	Fuel pump power supply	Output	Approximately 1 second or more after turning the ignition switch ON		0 V
				<ul style="list-style-type: none"> • Approximately 1 second after turning the ignition switch ON • Engine running 		Battery voltage

IPDM E/R

< ECU DIAGNOSIS INFORMATION >

Terminal No. (Wire color)		Description		Condition		Value (Approx.)	
+	-	Signal name	Input/ Output				
16 (LG)	Ground	Front wiper auto stop	Input	Ignition switch ON	Front wiper stop position	0 V	A
					Any position other than front wiper stop position	Battery voltage	B
19 (R)	Ground	Ignition relay power supply	Output	Ignition switch OFF		0 V	C
				Ignition switch ON		Battery voltage	
25 (G)	Ground	Ignition relay power supply	Output	Ignition switch OFF		0 V	D
				Ignition switch ON		Battery voltage	
26*1 (Y)	Ground	Ignition relay power supply	Output	Ignition switch OFF		0 V	E
				Ignition switch ON		Battery voltage	
27 (BG)	Ground	Ignition relay monitor	Input	Ignition switch OFF or ACC		Battery voltage	
				Ignition switch ON		0 V	
28 (L)	Ground	Push-button ignition switch	Input	Press the push-button ignition switch		0 V	F
				Release the push-button ignition switch		Battery voltage	
30 (GR)	Ground	Starter relay control	Input	A/T models	Selector lever in any position other than P or N (Ignition switch ON)	0 V	G
					Selector lever P or N (Ignition switch ON)	Battery voltage	H
				M/T models	Release the clutch pedal	0 V	
					Depress the clutch pedal	Battery voltage	
36 (G)	Ground	Battery power supply	Input	Ignition switch OFF		Battery voltage	I
39 (P)	—	CAN-L	Input/ Output	—		—	J
40 (L)	—	CAN-H	Input/ Output	—		—	
41 (B/W)	Ground	Ground	—	Ignition switch ON		0 V	SEC
42 (GR)	Ground	Cooling fan relay control	Input	Ignition switch OFF or ACC		0 V	L
				Ignition switch ON		0.7 V	
43*2 (G)	Ground	A/T shift selector (Detention switch)	Input	Ignition switch ON	<ul style="list-style-type: none"> Press the selector button (selector lever P) Selector lever in any position other than P 	Battery voltage	M
					Release the selector button (selector lever P)	0 V	N
44 (LG)	Ground	Horn relay control	Input	The horn is deactivated		Battery voltage	
				The horn is activated		0 V	
45 (V)	Ground	Anti theft horn relay control	Input	The horn is deactivated		Battery voltage	O
				The horn is activated		0 V	
46 (SB)	Ground	Starter relay control	Input	A/T models	Selector lever in any position other than P or N (Ignition switch ON)	0 V	P
					Selector lever P or N (Ignition switch ON)	Battery voltage	
				M/T models	Release the clutch pedal	0 V	
					Depress the clutch pedal	Battery voltage	

IPDM E/R

< ECU DIAGNOSIS INFORMATION >

Terminal No. (Wire color)		Description		Condition		Value (Approx.)
+	-	Signal name	Input/ Output			
48 (L)	Ground	A/C relay power supply	Output	Engine running	A/C switch OFF	0 V
					A/C switch ON (A/C compressor is operating)	Battery voltage
49 (BG)	Ground	ECM relay power supply	Output	Ignition switch OFF (More than a few seconds after turning ignition switch OFF)	0 V	
				<ul style="list-style-type: none"> • Ignition switch ON • Ignition switch OFF (For a few seconds after turning ignition switch OFF) 	Battery voltage	
51 (Y)	Ground	Ignition relay power supply	Output	Ignition switch OFF	0 V	
				Ignition switch ON	Battery voltage	
53 (W)	Ground	ECM relay power supply	Output	Ignition switch OFF (More than a few seconds after turning ignition switch OFF)	0 V	
				<ul style="list-style-type: none"> • Ignition switch ON • Ignition switch OFF (For a few seconds after turning ignition switch OFF) 	Battery voltage	
54 (P)	Ground	Throttle control motor relay power supply	Output	Ignition switch OFF (More than a few seconds after turning ignition switch OFF)	0 V	
				<ul style="list-style-type: none"> • Ignition switch ON • Ignition switch OFF (For a few seconds after turning ignition switch OFF) 	Battery voltage	
55 (SB)	Ground	ECM power supply	Output	Ignition switch OFF	Battery voltage	
56 (BR)	Ground	Ignition relay power supply	Output	Ignition switch OFF	0 V	
				Ignition switch ON	Battery voltage	
57 (G)	Ground	Ignition relay power supply	Output	Ignition switch OFF	0 V	
				Ignition switch ON	Battery voltage	
58*2 (GR)	Ground	Ignition relay power supply	Output	Ignition switch OFF	0 V	
				Ignition switch ON	Battery voltage	
69 (BR)	Ground	ECM relay control	Output	Ignition switch OFF (More than a few seconds after turning ignition switch OFF)	Battery voltage	
				<ul style="list-style-type: none"> • Ignition switch ON • Ignition switch OFF (For a few seconds after turning ignition switch OFF) 	0 - 1.5 V	
70 (BG)	Ground	Throttle control motor relay control	Output	Ignition switch ON → OFF	0 - 1.0 V ↓ Battery voltage ↓ 0 V	
				Ignition switch ON	0 - 1.0 V	
73*3 (P)	Ground	Ignition relay power supply	Output	Ignition switch OFF	0 V	
				Ignition switch ON	Battery voltage	

IPDM E/R

< ECU DIAGNOSIS INFORMATION >

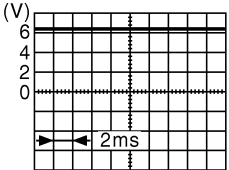
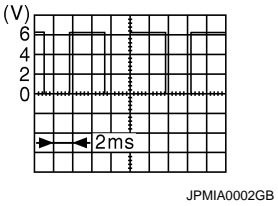
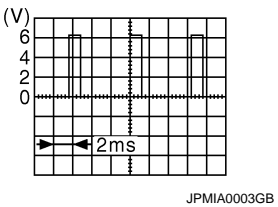
Terminal No. (Wire color)		Description		Condition		Value (Approx.)
+	-	Signal name	Input/ Output			
74 (G)	Ground	Ignition relay power supply	Output	Ignition switch OFF		0 V
				Ignition switch ON		Battery voltage
75 (SB)	Ground	Oil pressure switch	Input	Ignition switch ON	Engine stopped	0 V
					Engine running	Battery voltage
76 (Y)	Ground	Power generation command signal	Output	Ignition switch ON		 6.3 V
				40% is set on "ACTIVE TEST", "ALTERNATOR DUTY" of "ENGINE"		 3.8 V
				80% is set on "ACTIVE TEST", "ALTERNATOR DUTY" of "ENGINE"		 1.4 V
77 (R)	Ground	Fuel pump relay control	Output	<ul style="list-style-type: none"> Approximately 1 second after turning the ignition switch ON Engine running 		0 - 1.0 V
				Approximately 1 second or more after turning the ignition switch ON		Battery voltage
80 (W)	Ground	Starter motor	Output	At engine cranking		Battery voltage
83 (R)	Ground	Headlamp LO (RH)	Output	Ignition switch ON	Lighting switch OFF	0 V
					Lighting switch 2ND	Battery voltage
84 (V)	Ground	Headlamp LO (LH)	Output	Ignition switch ON	Lighting switch OFF	0 V
					Lighting switch 2ND	Battery voltage
86 (W)	Ground	Front fog lamp (RH)	Output	Lighting switch 2ND	Front fog lamp switch OFF	0 V
					<ul style="list-style-type: none"> Front fog lamp switch ON Daytime running light activated (Only for Canada) 	Battery voltage

A
B
C
D
E
F
G
H
I
J
L
M
N
O
P

SEC

IPDM E/R

< ECU DIAGNOSIS INFORMATION >

Terminal No. (Wire color)		Description		Condition		Value (Approx.)
+	-	Signal name	Input/ Output			
87 (L)	Ground	Front fog lamp (LH)	Output	Lighting switch 2ND	Front fog lamp switch OFF	0 V
					<ul style="list-style-type: none"> • Front fog lamp switch ON • Daytime running light activated (Only for Canada) 	Battery voltage
88 (G)	Ground	Washer pump power supply	Output	Ignition switch ON		Battery voltage
89 (BR)	Ground	Headlamp HI (RH)	Output	Ignition switch ON	Lighting switch OFF	0 V
					<ul style="list-style-type: none"> • Lighting switch HI • Lighting switch PASS 	Battery voltage
90 (P)	Ground	Headlamp HI (LH)	Output	Ignition switch ON	Lighting switch OFF	0 V
					<ul style="list-style-type: none"> • Lighting switch HI • Lighting switch PASS 	Battery voltage
91 (G)	Ground	Parking lamp (RH)	Output	Ignition switch ON	Lighting switch OFF	0 V
					Lighting switch 1ST	Battery voltage
92 (BG)	Ground	Parking lamp (LH)	Output	Ignition switch ON	Lighting switch OFF	0 V
					Lighting switch 1ST	Battery voltage
97 (V)	Ground	Cooling fan control	Output	Engine idling		0 - 5 V
104 (LG)	Ground	Hood switch	Input	Close the hood		Battery voltage
				Open the hood		0 V
105*4 (L)	Ground	Daytime running light relay control	Output	<ul style="list-style-type: none"> • Parking lamp • License plate lamp • Tail lamp 	Turned OFF	Battery voltage
					Turned ON	0 V

*1: Only for the models with ICC system

*2: A/T models only

*3: M/T models only

*4: Models with daytime running light system

IPDM E/R

< ECU DIAGNOSIS INFORMATION >

Wiring Diagram - IPDM E/R -

INFOID:000000007753454

For connector terminal arrangements, harness layouts, and alphabets in a  (option abbreviation; if not described in wiring diagram), refer to [GI-12, "Connector Information"](#).

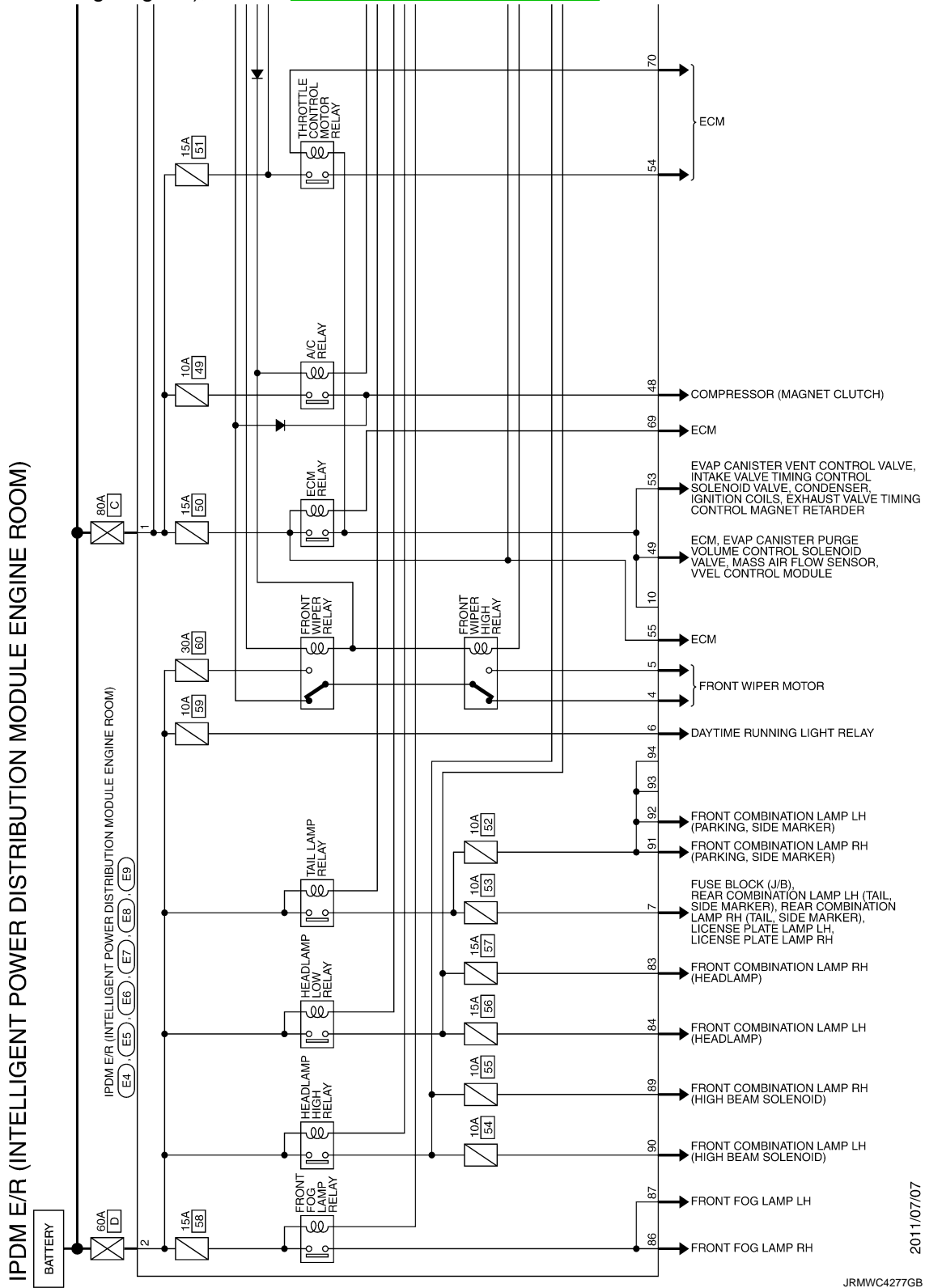

A
B
C
D
E
F
G
H
I
J
K
L
M
N
O
P

SEC

2011/07/07

JRMWC4277GB

IPDM E/R

< ECU DIAGNOSIS INFORMATION >

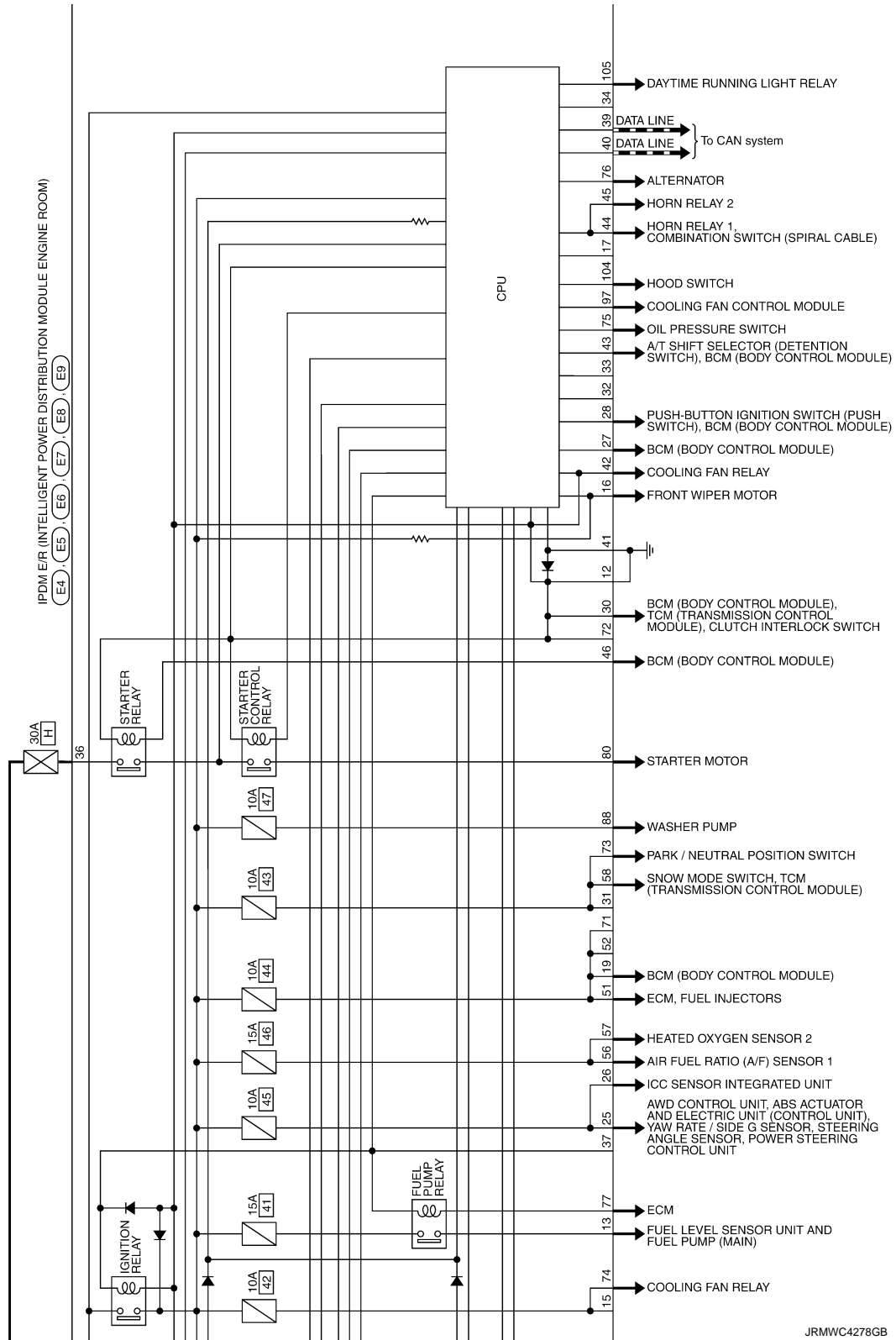

A
B
C
D
E
F
G
H
I
J
L
M
N
O
P

SEC

IPDM E/R
(INTELLIGENT POWER
DISTRIBUTION MODULE
ENGINE ROOM)
E4 . E5 . E6 .
E7 . E8 . E9 .

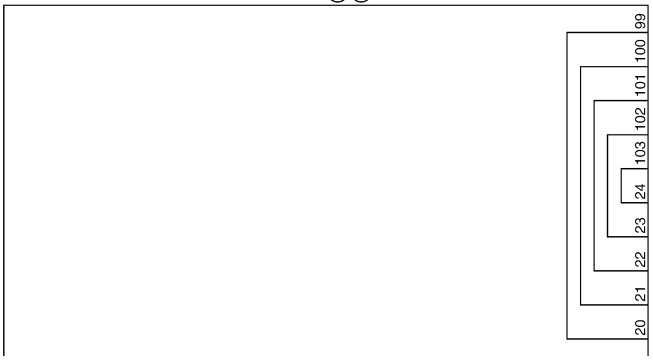

JRMWC4279GB

INFOID:000000007753455

Fail-safe

CAN COMMUNICATION CONTROL

When CAN communication with ECM and BCM is impossible, IPDM E/R performs fail-safe control. After CAN communication recovers normally, it also returns to normal control.

If No CAN Communication Is Available With ECM

IPDM E/R

< ECU DIAGNOSIS INFORMATION >

Control part	Fail-safe operation
Cooling fan	<ul style="list-style-type: none"> • Outputs the pulse duty signal (PWM signal) 100% when the ignition switch is turned ON • Outputs the pulse duty signal (PWM signal) 0% when the ignition switch is turned OFF
A/C compressor	A/C relay OFF
Alternator	Outputs the power generation command signal (PWM signal) 0%

If No CAN Communication Is Available With BCM

Control part	Fail-safe operation
Headlamp	<ul style="list-style-type: none"> • Turns ON the headlamp low relay when the ignition switch is turned ON • Turns OFF the headlamp low relay when the ignition switch is turned OFF • Headlamp high relay OFF
<ul style="list-style-type: none"> • Parking lamps • Side maker lamp • License plate lamps • Illuminations • Tail lamps 	<ul style="list-style-type: none"> • Turns ON the tail lamp relay when the ignition switch is turned ON • Turns OFF the tail lamp relay when the ignition switch is turned OFF
Front wiper	<ul style="list-style-type: none"> • The status just before activation of fail-safe control is maintained until the ignition switch is turned OFF while the front wiper is operating at LO or HI speed. • The wiper is operated at LO speed until the ignition switch is turned OFF if the fail-safe control is activated while the front wiper is set in the INT mode and the front wiper motor is operating.
Horn	Horn relay OFF
Ignition relay	The status just before activation of fail-safe is maintained.
Starter motor	Starter control relay OFF

IGNITION RELAY MALFUNCTION DETECTION FUNCTION

- IPDM E/R monitors the voltage at the contact circuit and excitation coil circuit of the ignition relay inside it.
- IPDM E/R judges the ignition relay error if the voltage differs between the contact circuit and the excitation coil circuit.
- If the ignition relay cannot turn OFF due to contact seizure, it activates the tail lamp relay for 10 minutes to alert the user to the ignition relay malfunction when the ignition switch is turned OFF.

Voltage judgment		IPDM E/R judgment	Operation
Ignition relay contact side	Ignition relay excitation coil side		
ON	ON	Ignition relay ON normal	—
OFF	OFF	Ignition relay OFF normal	—
ON	OFF	Ignition relay ON stuck	<ul style="list-style-type: none"> • Detects DTC “B2098: IGN RELAY ON” • Turns ON the tail lamp relay for 10 minutes
OFF	ON	Ignition relay OFF stuck	Detects DTC “B2099: IGN RELAY OFF”

FRONT WIPER CONTROL

IPDM E/R detects front wiper stop position by a front wiper stop position signal.

When a front wiper stop position signal is in the conditions listed below, IPDM E/R stops power supply to wiper after repeating a front wiper 10 seconds activation and 20 seconds stop five times.

Ignition switch	Front wiper switch	Front wiper stop position signal
ON	OFF	The front wiper stop position signal (stop position) cannot be input for 10 seconds.
	ON	The front wiper stop position signal does not change for 10 seconds.

NOTE:

This operation status can be confirmed on the IPDM E/R “Data Monitor” that displays “BLOCK” for the item “WIP PROT” while the wiper is stopped.

IPDM E/R

< ECU DIAGNOSIS INFORMATION >

STARTER MOTOR PROTECTION FUNCTION

IPDM E/R turns OFF the starter control relay to protect the starter motor when the starter control relay remains active for 90 seconds.

DTC Index

INFOID:000000007753456

NOTE:

- The details of time display are as follows.
- CRNT: A malfunction is detected now.
- PAST: A malfunction was detected in the past.
- IGN counter is displayed on FFD (Freeze Frame data).
- The number is 0 when is detected now.
- The number increases like 1 → 2 ... 38 → 39 after returning to the normal condition whenever IGN OFF → ON.
- The number is fixed to 39 until the self-diagnosis results are erased if it is over 39.

x: Applicable

CONSULT display	Fail-safe	Refer to
No DTC is detected. further testing may be required.	—	—
U1000: CAN COMM CIRCUIT	×	PCS-14
B2098: IGN RELAY ON	×	PCS-15
B2099: IGN RELAY OFF	—	PCS-16
B210B: START CONT RLY ON	—	SEC-83
B210C: START CONT RLY OFF	—	SEC-84
B210D: STARTER RELAY ON	—	SEC-85
B210E: STARTER RELAY OFF	—	SEC-86
B210F: INTRLCK/PNP SW ON	—	SEC-88
B2110: INTRLCK/PNP SW OFF	—	SEC-90

SEC

ENGINE DOES NOT START WHEN INTELLIGENT KEY IS INSIDE OF VEHICLE

< SYMPTOM DIAGNOSIS >

SYMPTOM DIAGNOSIS

ENGINE DOES NOT START WHEN INTELLIGENT KEY IS INSIDE OF VEHICLE

Description

INFOID:000000007467341

Engine does not start when push-button ignition switch is pressed while carrying Intelligent Key.

NOTE:

- Check that vehicle is under the condition shown in “Conditions of vehicle” before starting diagnosis, and check each symptom.
- The engine start function, door lock function, power distribution system, and NATS-IVIS/NVIS in the Intelligent Key system are closely related to each other regarding control. The vehicle security function can operate only when the door lock and power distribution system are operating normally.

Conditions of Vehicle (Operating Conditions)

- “ENGINE START BY I-KEY” in “WORK SUPPORT” is ON when setting on CONSULT.
- Intelligent Key is not inserted in key slot.
- One or more of Intelligent Keys with registered Intelligent Key ID is in the vehicle.

Diagnosis Procedure

INFOID:000000007467342

1. CHECK INTELLIGENT KEY SYSTEM (DOOR LOCK FUNCTION)

Lock/unlock door with door request switch.

Refer to [DLK-21, "DOOR LOCK FUNCTION : System Description"](#).

Is the operation normal?

YES >> GO TO 2.

NO >> Check Intelligent Key system (door lock function). Refer to [DLK-158, "ALL DOOR : Diagnosis Procedure"](#).

2. PERFORM WORK SUPPORT

Perform “INSIDE ANT DIAGNOSIS” on Work Support in “INTELLIGENT KEY”.

Refer to [SEC-26, "INTELLIGENT KEY : CONSULT Function \(BCM - INTELLIGENT KEY\)"](#).

>> GO TO 3.

3. PERFORM SELF DIAGNOSTIC RESULT

Perform Self Diagnostic Result in “BCM”, and check whether or not DTC of inside key antenna is detected.

Is DTC detected?

YES >> Refer to [DLK-59, "DTC Logic"](#) (instrument center), [DLK-61, "DTC Logic"](#) (console) or [DLK-63, "DTC Logic"](#) (trunk room).

NO >> GO TO 4.

4. CHECK PUSH-BUTTON IGNITION SWITCH

Check push-button ignition switch.

Refer to [PCS-62, "Component Function Check"](#).

Is the operation normal?

YES >> GO TO 5.

NO >> Repair or replace malfunctioning parts.

5. CONFIRM THE OPERATION

Confirm the operation again.

Is the inspection normal?

YES >> Check intermittent incident. Refer to [GI-43, "Intermittent Incident"](#).

NO >> GO TO 1.

SECURITY INDICATOR LAMP DOES NOT TURN ON OR FLASH

< SYMPTOM DIAGNOSIS >

SECURITY INDICATOR LAMP DOES NOT TURN ON OR FLASH

Description

INFOID:000000007467345

Security indicator lamp does not blink when ignition switch is in a position other than ON

NOTE:

- Before performing the diagnosis, check "Work Flow". Refer to [SEC-5, "Work Flow"](#).
- Check that vehicle is under the condition shown in "Conditions of vehicle" before starting diagnosis, and check each symptom.

Conditions of Vehicle (Operating Conditions)

- Intelligent Key is not inserted in key slot.
- Ignition switch is not in the ON position.

Diagnosis Procedure

INFOID:000000007467346

1. CHECK SECURITY INDICATOR LAMP

Check security indicator lamp.

Refer to [SEC-99, "Component Function Check"](#).

Is the inspection result normal?

YES >> GO TO 2.

NO >> Repair or replace the malfunctioning parts.

2. CONFIRM THE OPERATION

Confirm the operation again.

Is the result normal?

YES >> Check intermittent incident. Refer to [GI-43, "Intermittent Incident"](#).

NO >> GO TO 1.

A
B
C
D
E
F
G
H
I
J
L
M
N
O
P

SEC

VEHICLE SECURITY SYSTEM CANNOT BE SET

< SYMPTOM DIAGNOSIS >

VEHICLE SECURITY SYSTEM CANNOT BE SET INTELLIGENT KEY

INTELLIGENT KEY : Description

INFOID:000000007467347

Armed phase is not activated when door is locked using Intelligent Key.

NOTE:

Check that vehicle is under the condition shown in “Conditions of vehicle” before starting diagnosis, and check each symptom.

CONDITION OF VEHICLE (OPERATING CONDITION)

Confirm the setting of “SECURITY ALARM SET” in “WORK SUPPORT” in “THEFT ALM” using CONSULT.

INTELLIGENT KEY : Diagnosis Procedure

INFOID:000000007467348

1. CHECK INTELLIGENT KEY SYSTEM (REMOTE KEYLESS ENTRY FUNCTION)

Lock/unlock door with Intelligent Key.

Refer to [DLK-21, "DOOR LOCK FUNCTION : System Description"](#).

Is the inspection result normal?

YES >> GO TO 2.

NO >> Check Intelligent Key system (remote keyless entry function). Refer to [DLK-160, "Diagnosis Procedure"](#).

2. CHECK HOOD SWITCH

Check hood switch.

Refer to [SEC-97, "Component Function Check"](#).

Is the inspection result normal?

YES >> GO TO 3.

NO >> Repair or replace the malfunctioning parts.

3. CONFIRM THE OPERATION

Confirm the operation again.

Is the result normal?

YES >> Check intermittent incident. Refer to [GI-43, "Intermittent Incident"](#).

NO >> GO TO 1.

DOOR REQUEST SWITCH

DOOR REQUEST SWITCH : Description

INFOID:000000007467349

Armed phase is not activated when door is locked using door request switch.

NOTE:

Check that vehicle is under the condition shown in “Conditions of vehicle” before starting diagnosis, and check each symptom.

CONDITION OF VEHICLE (OPERATING CONDITION)

Confirm the setting of “SECURITY ALARM SET” in “WORK SUPPORT” in “THEFT ALM” using CONSULT.

DOOR REQUEST SWITCH : Diagnosis Procedure

INFOID:000000007467350

1. CHECK INTELLIGENT KEY SYSTEM (DOOR LOCK FUNCTION)

Lock/unlock door with door request switch.

Refer to [DLK-21, "DOOR LOCK FUNCTION : System Description"](#).

Is the inspection result normal?

YES >> GO TO 2.

NO >> Check Intelligent Key system (door lock function). Refer to [DLK-160, "Diagnosis Procedure"](#).

2. CHECK HOOD SWITCH

Check hood switch.

VEHICLE SECURITY SYSTEM CANNOT BE SET

< SYMPTOM DIAGNOSIS >

Refer to [SEC-97, "Component Function Check"](#).

Is the inspection result normal?

YES >> GO TO 3.

NO >> Repair or replace the malfunctioning parts.

3. CONFIRM THE OPERATION

Confirm the operation again.

Is the result normal?

YES >> Check intermittent incident. Refer to [GI-43, "Intermittent Incident"](#).

NO >> GO TO 1.

A

B

C

D

E

F

G

H

I

J

SEC

L

M

N

O

P

VEHICLE SECURITY ALARM DOES NOT ACTIVATE

< SYMPTOM DIAGNOSIS >

VEHICLE SECURITY ALARM DOES NOT ACTIVATE

Description

INFOID:000000007467351

Alarm does not operate when alarm operating condition is satisfied.

NOTE:

Check that vehicle is under the condition shown in "Conditions of vehicle" before starting diagnosis, and check each symptom.

CONDITIONS OF VEHICLE (OPERATING CONDITIONS)

"SECURITY ALARM SET" in "WORK SUPPORT" of "THEFT ALM" is ON when setting on CONSULT.

Diagnosis Procedure

INFOID:000000007467352

1.CHECK DOOR SWITCH

Check door switch.

Refer to [DLK-66. "Component Function Check"](#).

Is the inspection result normal?

YES >> GO TO 2.

NO >> Replace the malfunctioning door switch

2.CHECK HOOD SWITCH

Check hood switch.

Refer to [SEC-97. "Component Function Check"](#).

Is the inspection result normal?

YES >> GO TO 3.

NO >> Repair or replace the malfunctioning parts.

3.CHECK HEADLAMP

Check headlamp.

Refer to [EXL-36. "Component Function Check"](#).

Is the inspection result normal?

YES >> GO TO 4.

NO >> Repair or replace the malfunctioning parts.

4.CHECK HORN

Check horn.

Refer to [HRN-2. "Wiring Diagram - HORN -"](#).

Is the inspection result normal?

YES >> GO TO 5.

NO >> Repair or replace the malfunctioning parts.

5.CONFIRM THE OPERATION

Confirm the operation again.

Is the result normal?

YES >> Check intermittent incident. Refer to [GI-43. "Intermittent Incident"](#).

NO >> GO TO 1.

INTELLIGENT KEY INSERT INFORMATION DOES NOT OPERATE

< SYMPTOM DIAGNOSIS >

INTELLIGENT KEY INSERT INFORMATION DOES NOT OPERATE

Description

INFOID:000000007467353

Intelligent Key insert information does not operate when push-button ignition switch is operated while Intelligent Key is not inside vehicle.

NOTE:

Warning functions operating condition is extremely complicated. During operation confirmation reconfirm the list above twice in order to ensure proper operation. Refer to [DLK-40, "WARNING FUNCTION : System Description"](#).

Diagnosis Procedure

INFOID:000000007467354

1.CHECK POWER POSITION

Check if ignition switch position is changing or not.

Does ignition switch position change?

YES >> GO TO 3.

NO >> GO TO 2.

2.CHECK PUSH-BUTTON IGNITION SWITCH

Check push-button ignition switch.

Refer to [PCS-62, "Component Function Check"](#).

Is the inspection result normal?

YES >> Check BCM for DTC. Refer to [SEC-139, "DTC Index"](#).

NO >> Repair or replace the malfunctioning parts.

3.CHECK DOOR SWITCH

Check door switch.

Refer to [DLK-66, "Component Function Check"](#).

Is the inspection result normal?

YES >> GO TO 4.

NO >> Repair or replace the malfunctioning parts.

4.CHECK KEY SLOT

Check key slot.

Refer to [SEC-94, "Component Function Check"](#).

Is the inspection result normal?

YES >> GO TO 5.

NO >> Repair or replace the malfunctioning parts.

5.CHECK COMBINATION METER DISPLAY

Check combination meter display.

Refer to [DLK-108, "Component Function Check"](#).

Is the inspection result normal?

YES >> GO TO 6.

NO >> Repair or replace the malfunctioning parts.

6.CHECK KEY SLOT INDICATOR

Check key slot indicator.

Refer to [SEC-95, "Component Function Check"](#).

Is the inspection result normal?

YES >> GO TO 7.

NO >> Repair or replace the malfunctioning parts.

7.CONFIRM THE OPERATION

Confirm the operation again.

Is the result normal?

INTELLIGENT KEY INSERT INFORMATION DOES NOT OPERATE

< SYMPTOM DIAGNOSIS >

YES >> Check intermittent incident. Refer to [GI-43, "Intermittent Incident"](#).
NO >> GO TO 1.

PRECAUTIONS

< PRECAUTION >

PRECAUTION

PRECAUTIONS

Precaution for Supplemental Restraint System (SRS) "AIR BAG" and "SEAT BELT PRE-TENSIONER"

INFOID:000000007467355

The Supplemental Restraint System such as "AIR BAG" and "SEAT BELT PRE-TENSIONER", used along with a front seat belt, helps to reduce the risk or severity of injury to the driver and front passenger for certain types of collision. This system includes seat belt switch inputs and dual stage front air bag modules. The SRS system uses the seat belt switches to determine the front air bag deployment, and may only deploy one front air bag, depending on the severity of a collision and whether the front occupants are belted or unbelted. Information necessary to service the system safely is included in the "SRS AIR BAG" and "SEAT BELT" of this Service Manual.

WARNING:

Always observe the following items for preventing accidental activation.

- To avoid rendering the SRS inoperative, which could increase the risk of personal injury or death in the event of a collision that would result in air bag inflation, all maintenance must be performed by an authorized NISSAN/INFINITI dealer.
- Improper maintenance, including incorrect removal and installation of the SRS, can lead to personal injury caused by unintentional activation of the system. For removal of Spiral Cable and Air Bag Module, see "SRS AIR BAG".
- Never use electrical test equipment on any circuit related to the SRS unless instructed to in this Service Manual. SRS wiring harnesses can be identified by yellow and/or orange harnesses or harness connectors.

PRECAUTIONS WHEN USING POWER TOOLS (AIR OR ELECTRIC) AND HAMMERS

WARNING:

Always observe the following items for preventing accidental activation.

- When working near the Air Bag Diagnosis Sensor Unit or other Air Bag System sensors with the ignition ON or engine running, never use air or electric power tools or strike near the sensor(s) with a hammer. Heavy vibration could activate the sensor(s) and deploy the air bag(s), possibly causing serious injury.
- When using air or electric power tools or hammers, always switch the ignition OFF, disconnect the battery, and wait at least 3 minutes before performing any service.

Precaution for Procedure without Cowl Top Cover

INFOID:000000007467357

When performing the procedure after removing cowl top cover, cover the lower end of windshield with urethane, etc to prevent damage to windshield.

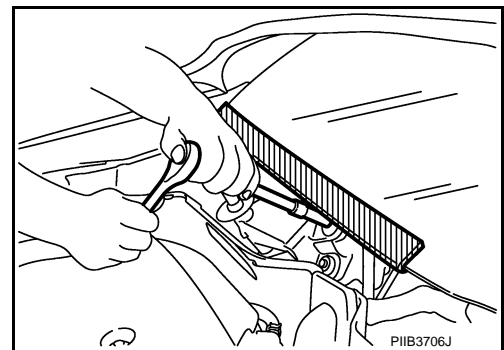

KEY SLOT

< REMOVAL AND INSTALLATION >

REMOVAL AND INSTALLATION

KEY SLOT

Exploded View

INFOID:000000007467358

Refer to [IP-11, "A/T MODELS : Exploded View"](#).

Removal and Installation

INFOID:000000007467359

REMOVAL

1. Remove the instrument driver lower panel (2). Refer to [IP-12, "A/T MODELS : Removal and Installation"](#).
2. Disconnect key slot connector.
3. Remove the key slot mounting screw (A), and then remove key slot (1) from instrument driver lower panel (2).

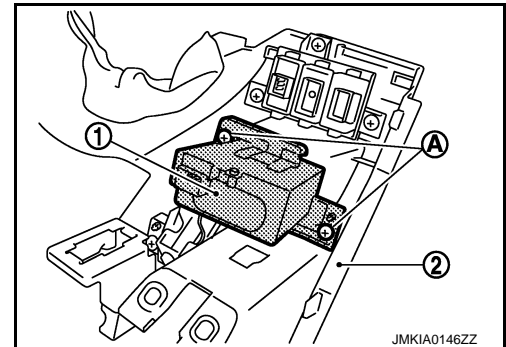

INSTALLATION

Install in the reverse order of removal.

PUSH BUTTON IGNITION SWITCH

< REMOVAL AND INSTALLATION >

PUSH BUTTON IGNITION SWITCH

Exploded View

INFOID:000000007467360

Refer to [JP-11, "A/T MODELS : Exploded View"](#).

Removal and Installation

INFOID:000000007467361

REMOVAL

1. Remove the cluster lid A assembly. Refer to [IP-12, "A/T MODELS : Removal and Installation"](#).
2. Remove the push-button ignition switch (1) from cluster lid A assembly, and then remove pawl (A). Press push-button ignition switch (1) back to disengage from cluster lid A assembly.

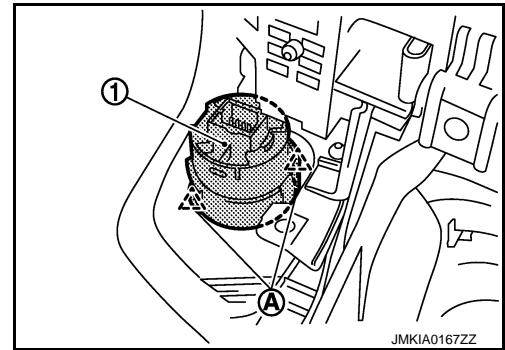

INSTALLATION

Install in the reverse order of removal.

A
B
C
D
E
F
G
H
I
J
L
M
N
O
P

SEC